



**Application Note**

# **AN5000**

# **Rotary Magnetic**

# **Position Sensors**

## **Magnet Selection Guide**

## Content Guide

|       |   |    |
|-------|---|----|
| 1     | Introduction .....                            | 3  |
| 1.1   | Purpose .....                                 | 3  |
| 1.2   | Measurement principle .....                   | 3  |
| 1.3   | Magnetic input range .....                    | 5  |
| 1.4   | Magnetic field measurement location .....     | 6  |
| 1.5   | Non linearity definition .....                | 7  |
| 1.6   | Mechanical orientation and misalignment ..... | 9  |
| 1.6.1 | Vertical distance change .....                | 9  |
| 1.6.2 | Horizontal distance change .....              | 11 |
| 2     | Magnets .....                                 | 13 |
| 2.1   | Magnet materials .....                        | 13 |
| 2.2   | Magnet dimensions .....                       | 13 |
| 2.2.1 | Thickness increase of magnets .....           | 14 |
| 2.2.2 | Diameter increase of magnets .....            | 15 |
| 2.3   | Magnetic grades .....                         | 16 |
| 2.4   | Magnetization types .....                     | 18 |
| 2.5   | Magnetization errors .....                    | 18 |
| 2.6   | Temperature effects on magnets .....          | 19 |
| 2.7   | Mounting the magnet .....                     | 20 |
| 3     | Magnet suppliers .....                        | 22 |
| 3.1   | Magnets on AMS web shop .....                 | 22 |
| 4     | Contact Information .....                     | 24 |
| 5     | Copyrights & Disclaimer .....                 | 25 |
| 6     | Revision Information .....                    | 26 |

## 1 Introduction

### 1.1 Purpose

The purpose of this Application Note is to explain the fundamental principles of ams AG magnetic position sensors. In addition the selection of proper magnets is highlighted. This application note covers all on axis single or dual magnetic position sensors products. Important aspects for magnet selection e.g. temperature effects are described.

### 1.2 Measurement principle

ams' magnetic position sensor products uses a patented differential measurement principle. These circuits are using integrated lateral Hall sensors in standard CMOS technology. Lateral Hall elements are sensitive to the magnetic field component perpendicular to their surface. This means they are only sensitive to magnetic fields vertical to the IC surface. The magnetic flux density in z-direction  $B_z$  is measured and horizontal  $B_x$  and  $B_y$  components are not measured at all.

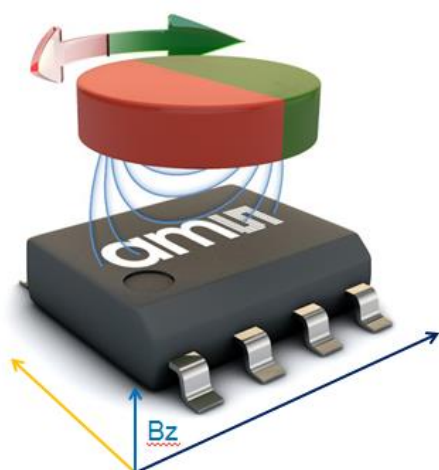

Figure 1: On-axis magnetic position sensor IC + magnet

The magnetic position sensor circuits are a system-on-chip, they contain all components required to create a non-contact rotation angle position measurement system. Basically, the only external component required is a magnet rotating over the surface of the IC. Depending on the use case (target accuracy, vertical air gap, temperature range and mounting possibilities), different magnets are used.

In this type of measurement, a magnet rotates over the chip such that

- the center of the magnet,
- the center of rotation
- and the center of the chip

are in one vertical line (see Figure 1).

The integrated Hall sensors of the sensor IC are arranged in a circle using different diameters depending on the product (see Table 1). The principle for rotation angle measurement requires that the Hall elements on the IC can sense a full magnetic period as the magnet rotates. This requirement is obtained by using a diametrically magnetized magnet.

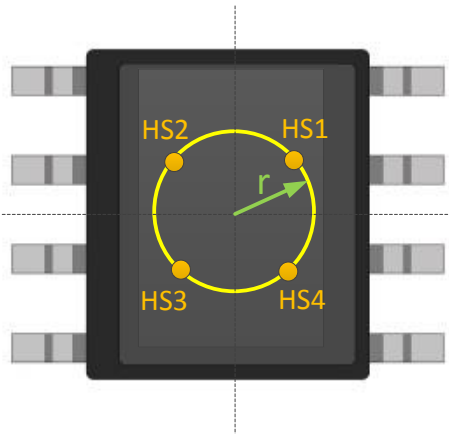

Figure 2: Example Hall sensor locations and measurement radius

Figure 2 shows the circular arrangement of the Hall sensors HS1 – HS4. The rotary position sensor model can be mathematically described as following:

$$Signal_1 = +V_{HS1} + V_{HS2} - V_{HS3} - V_{HS4}$$

$$Signal_2 = +V_{HS1} - V_{HS2} - V_{HS3} + V_{HS4}$$

$$\alpha = ATAN2(Signal_1, Signal_2)$$

*Note: The purpose of using ATAN2 instead of ATAN is to gather information on the signs of the inputs in order to return the appropriate quadrant of the computed angle. ATAN2 provides an angle output over the full range 0-360 degrees.*

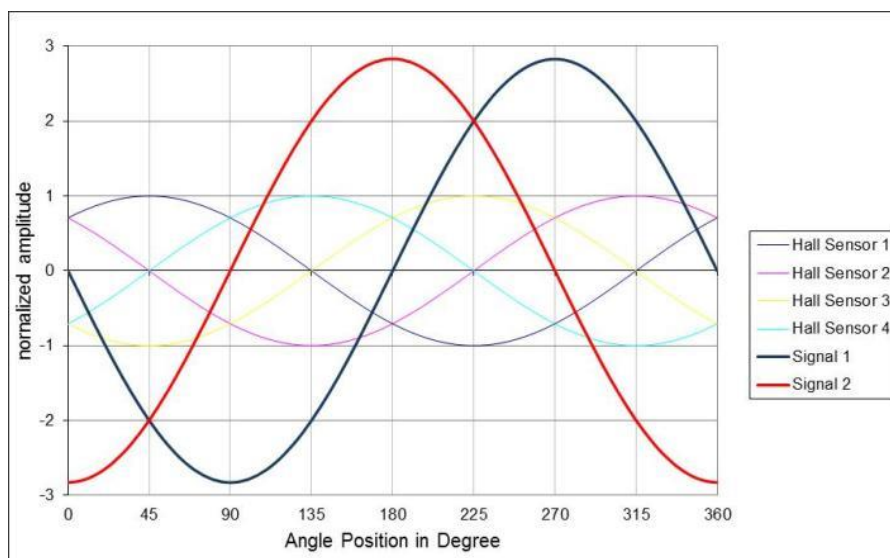

Figure 3 Internal signals of Hall sensors HS1-HS4 and resulting signals

As the magnet rotates over the chip, the Hall sensors create sinusoidal signals. The four individual Hall sensor output signals are subtracted and summed according to the formulas. The resulting signals are 90° phase shifted and represent sine and cosine signals. The ATAN2 algorithm is used to calculate the angle over the complete measurement range of 360 degrees. This method is capable of measuring absolute angle information.

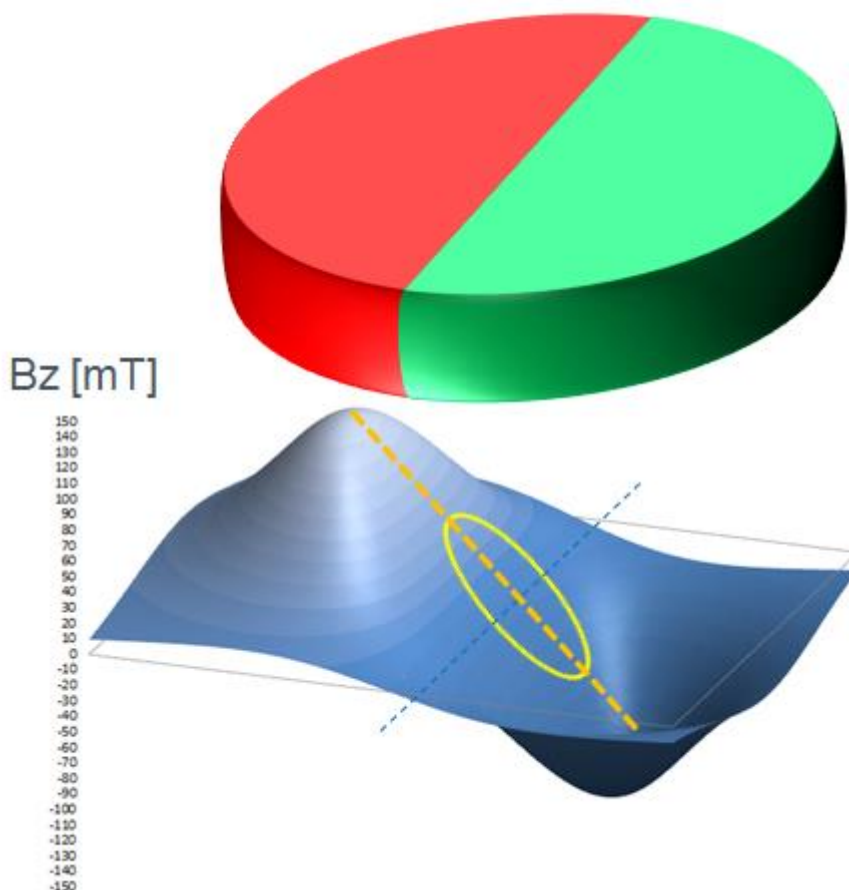

Figure 4 3D Graph of magnetic flux density  $B_z$

Magnetic scanning of a diametric magnetized magnet with a given z-distance (air gap) will lead to Figure 4. The yellow track indicates the projection of the circle of the Hall element array on the 3D scan. This given linear area makes the sensor system tolerant against mechanical misalignments over a certain mechanical range.

### 1.3 Magnetic input range

Magnetic position sensor datasheets specifies the required magnetic flux density  $B_z$ . This refers to the best mechanical alignment case. Figure 5 shows the sinusoidal distribution of the flux density. Figure 9 shows the green zone of required input range. This zone varies between different magnetic position sensor products. Mechanical displacements will cause a magnetic offset shift in the measured individual signals. Therefore a relative extraction according the formula is recommended. The sensor system operates also in case of exceeding the absolute magnetic flux density.

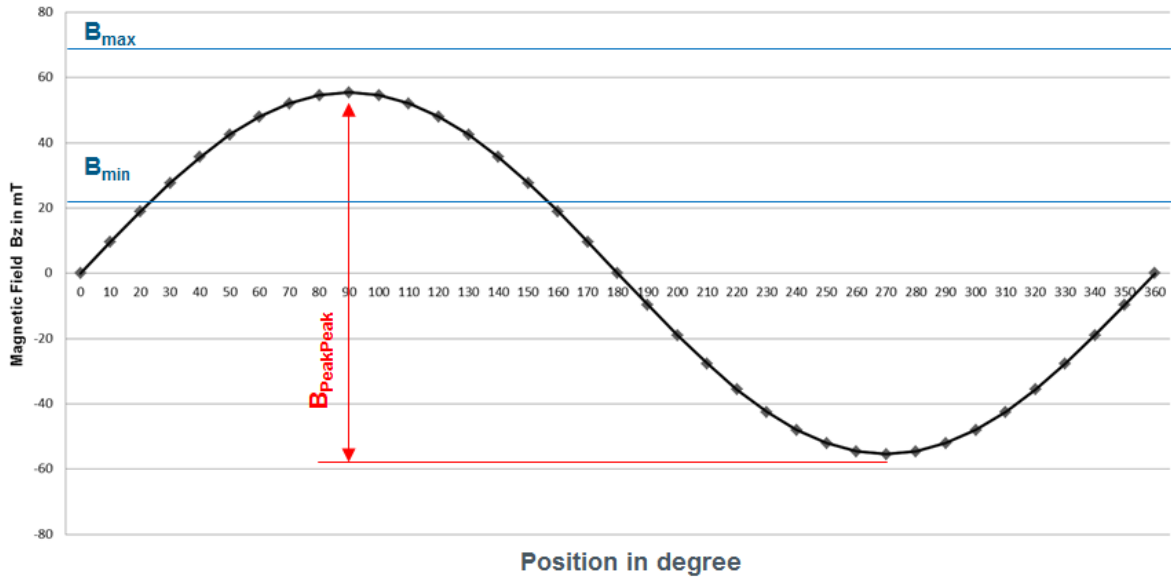

Figure 5 Magnetic flux density at the circular measurement track

Formula for relative extraction of the magnetic flux density. Static magnetic offset shift is ignored.

$$B_{min} \leq \frac{B_{PeakPeak}}{2} \leq B_{max}$$

### 1.4 Magnetic field measurement location

Magnetic position sensor datasheets specify the required magnetic flux density on the sensor die surface and not on the package surface. Cross sections of the different packages show the mechanical distance. Table 1 summarizes these parameters.

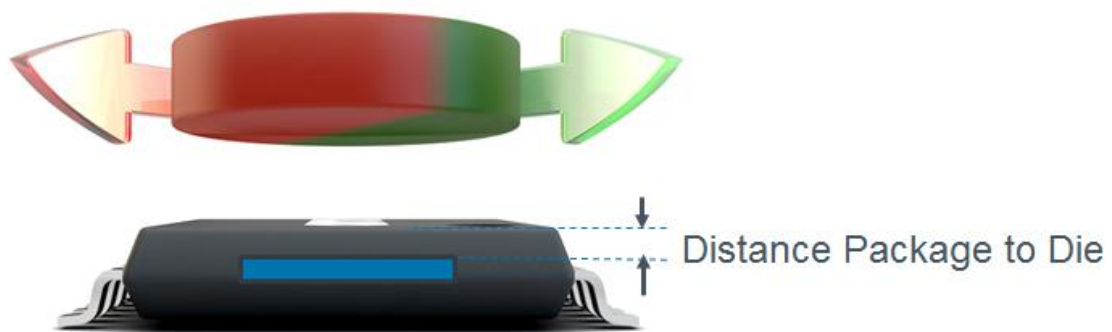

Figure 6 Air gap and distance package surface to die surface

Table 1 Magnetic Position Sensor Product Matrix – Overview single die sensor

| Product                   | AS5115<br>AS5132<br>AS5134 | AS5040<br>AS5145<br>AS5045B              | AS5162<br>AS5161   | AS5050A<br>AS5055A | AS5048A<br>AS5048B | AS5047D<br>AS5147<br>AS5047P<br>AS5147P | AS5600<br>AS5601   |
|---------------------------|----------------------------|--|--------------------|--------------------|--------------------|---|--------------------|
| Sensor Radius [mm]        | 1.0                        | 1.1                                      | 1.25               | 1.0                | 1.1                | 1.1                                     | 1.0                |
| Magnetic Input Range [mT] | 20-80                      | 45-75 <sup>1</sup><br>22-84 <sup>2</sup> | 10-90 <sup>3</sup> | 30-90              | 30-70              | 35-70                                   | 30-90 <sup>4</sup> |
| Die→Package Surface [mm]  | 0.576<br>SSOP              | 0.576<br>SSOP                            | 0.459<br>SOIC8     | 0.383<br>QFN       | 0.306<br>TSSOP     | 0.306<br>TSSOP                          | 0.459<br>SOIC8     |

Table 1 summarizes the three import parameters required for simulation and selection of magnets.

Table 2 Magnetic Position Sensor Product Matrix – Overview dual die sensor

| Product                   | AS5215                                   | AS5245                                   | AS5262<br>AS5261                         | AS5247                                   |
|---------------------------|--|--|--|--|
| Sensor Radius [mm]        | 1.0                                      | 1.1                                      | 1.25                                     | 1.1                                      |
| Magnetic Input Range [mT] | 20-80                                    | 45-75 <sup>1</sup><br>22-84 <sup>2</sup> | 10-90 <sup>3</sup>                       | 35-70                                    |
| Die→Package Surface [mm]  | 0.234 Top Die<br>0.607 Bottom Die<br>MLF | 0.234 Top Die<br>0.607 Bottom Die<br>MLF | 0.234 Top Die<br>0.607 Bottom Die<br>MLF | 0.234 Top Die<br>0.611 Bottom Die<br>MLF |

Table 2 summarizes the three import parameters required for simulation and selection of magnets

## 1.5 Non linearity definition

The integral non linearity (INL) is one of the important parameters for position sensors in general. This parameter specifies the effective angle error from the total system. The magnetic position sensor system performance is mainly dependent on magnetic and mechanical constraints. Electrical errors from position sensor IC play mostly a minor role.

<sup>1</sup> Magnetic input range for green range

<sup>2</sup> Magnetic input range for yellow range

<sup>3</sup> Extended mode selected

<sup>4</sup> Lost magnet diagnostic at 8 mT

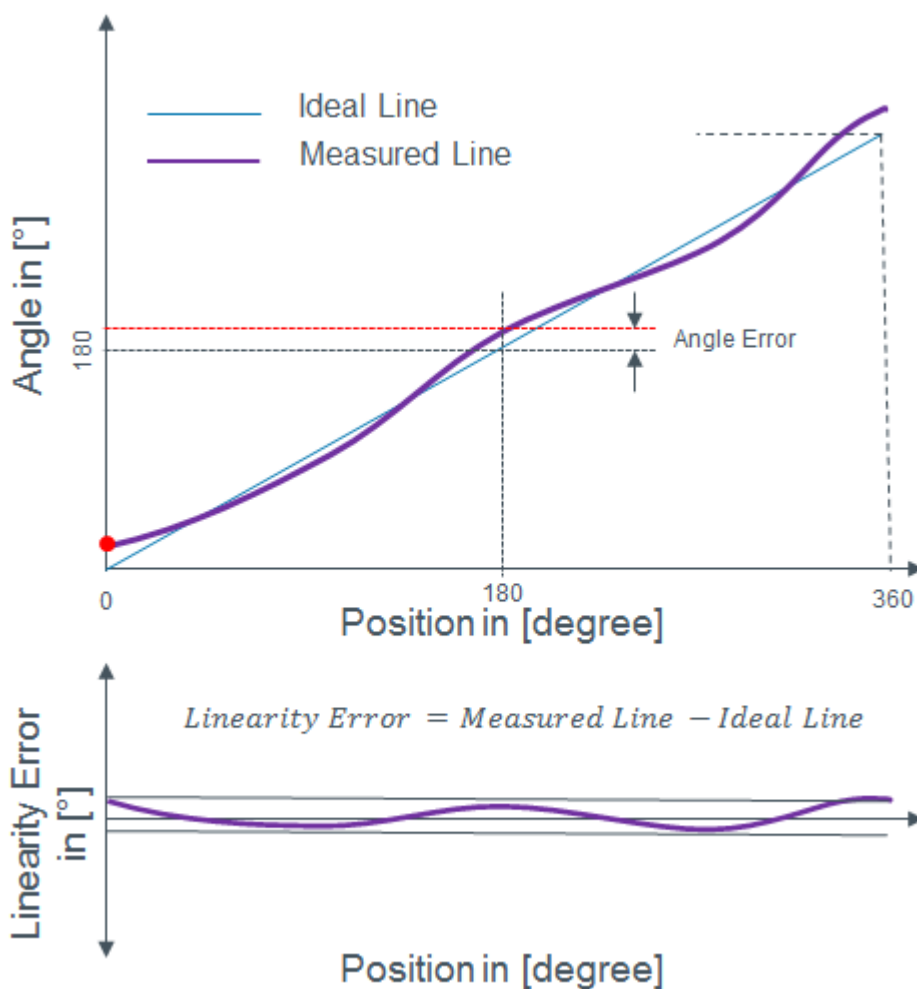

Figure 7 Non Linearity of the angle output

$$INL\ Error = \frac{Linearity\ Error\ max - Linearity\ Error\ min}{2}$$

The non-linearity parameter represents the difference between the measured and the ideal line. The formula above extracts the relative angle error. Offset angle components are not considered in this calculation. (Best-Line-Fit method).



## 1.6 Mechanical orientation and misalignment

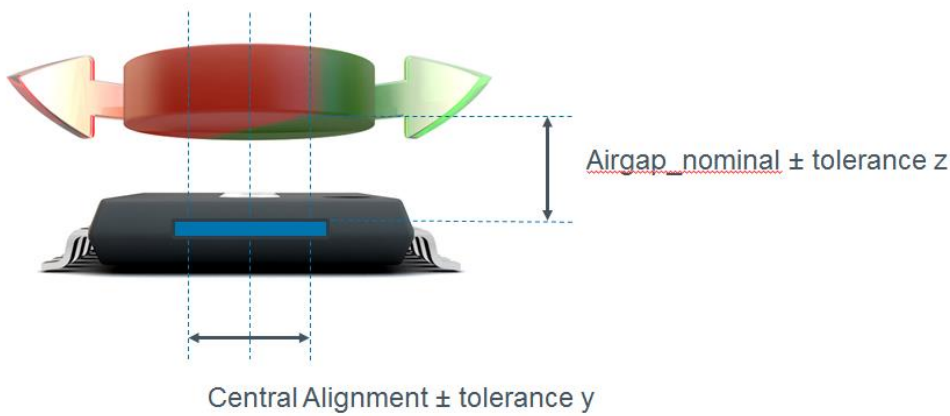

Figure 8 Mechanical misalignments in vertical and horizontal direction

Two mechanical parameters and tolerances are important. The magnetic flux density changes with bigger air-gaps. The linearity changes with mechanical displacements in x and y direction.

### 1.6.1 Vertical distance change

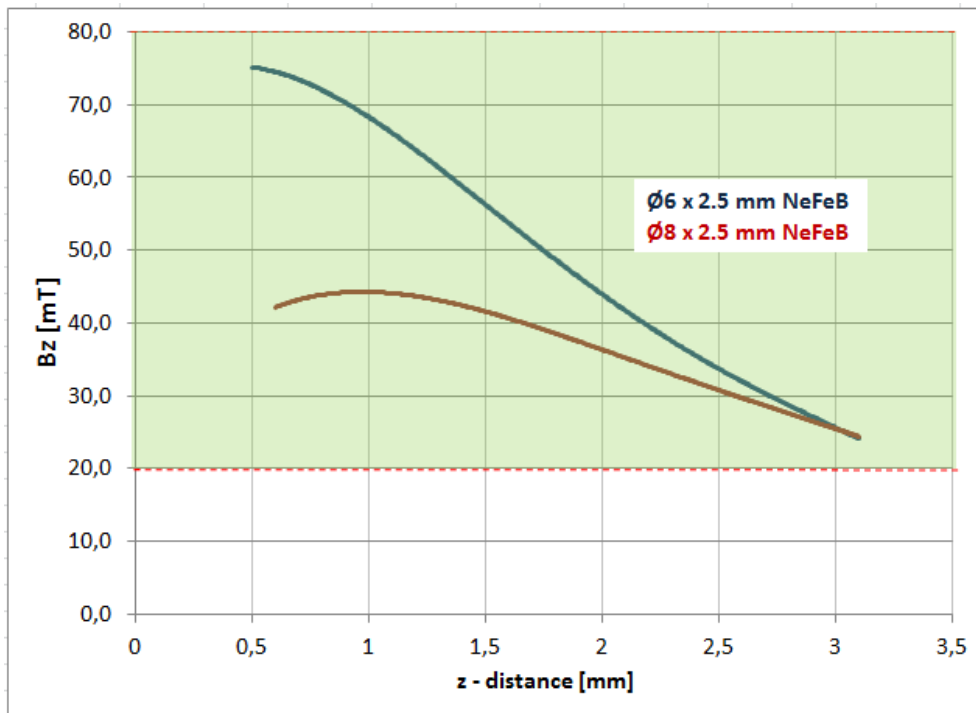

Figure 9 shows the difference between 6 and 8 mm diameter magnet (N35H).

The vertical distance from IC package surface to the magnet surface (air gap) is in addition an important parameter for the linearity parameter of the system. Due to magnetic properties an optimum can be chosen.

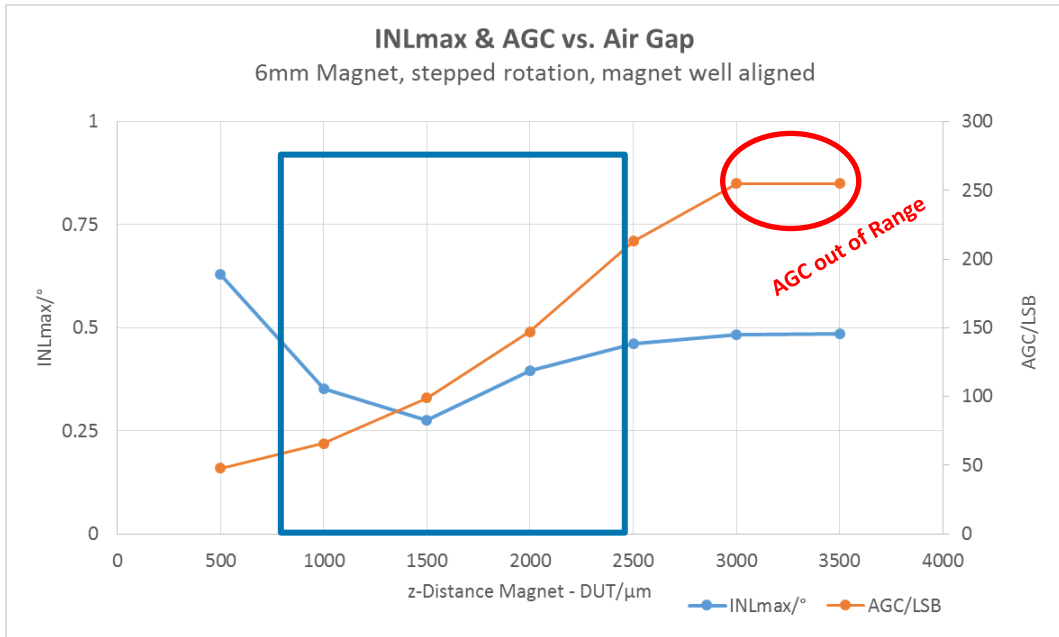

Figure 10 Nonlinearity and Automatic Gain Control (AGC) value over air gap. D6H2.5 magnet.

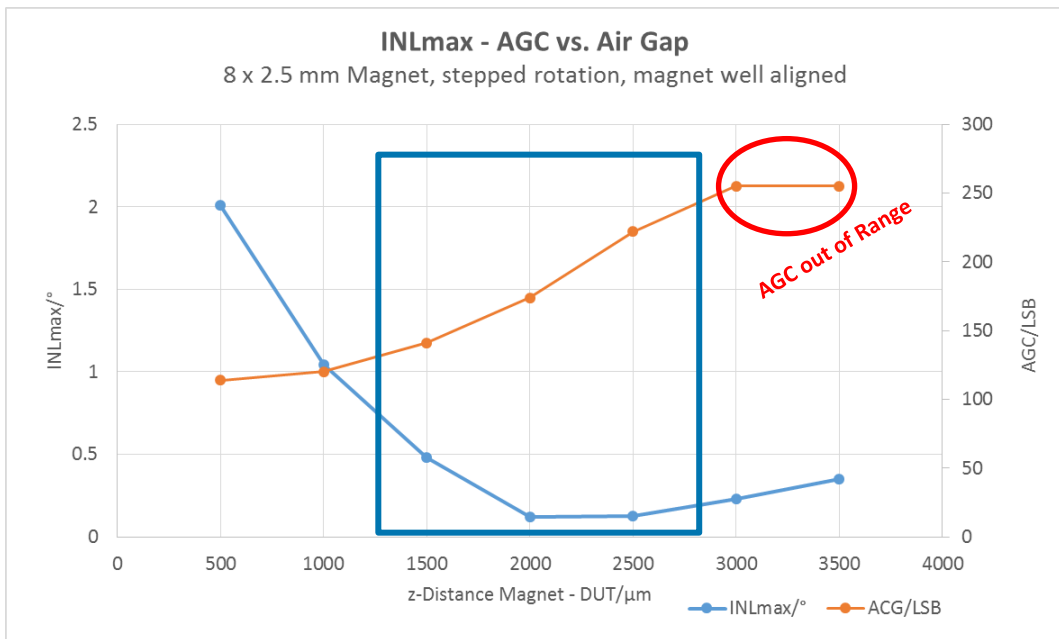

Figure 11 Nonlinearity and Automatic Gain Control (AGC) value over air gap. D8H2.5 magnet.

Figure 10 and Figure 11 show the tendency of the non-linearity choosing different air gaps. Both settings have their best operating points. In addition the automatic gain control value is shown. This value is increasing with increasing distance with reaching the limit at to large air gaps. The magnetic position sensor is still operating in this area with slightly increased noise output. Magnetic field warning flags can be set by the position sensor in this region.

### 1.6.2 Horizontal distance change

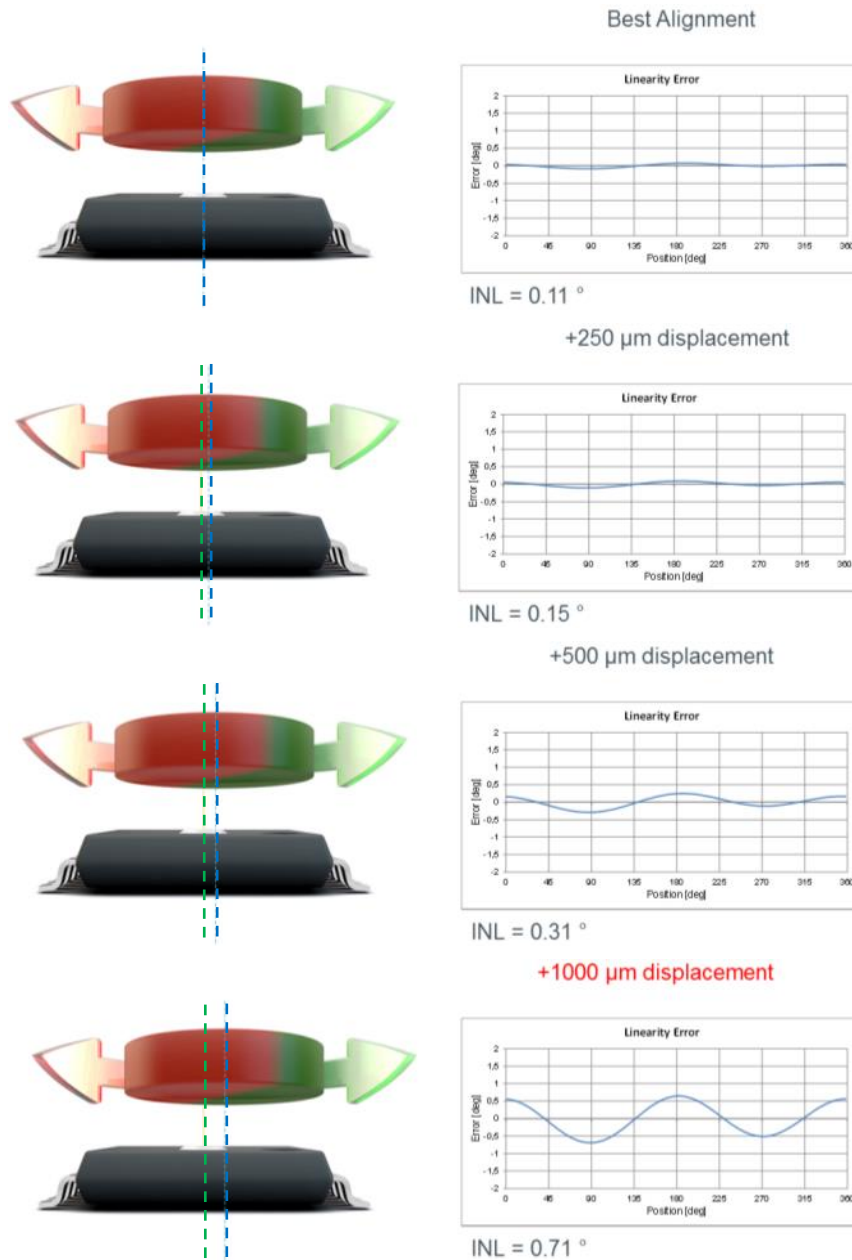

Figure 12 Non-Linearity change over horizontal misalignment

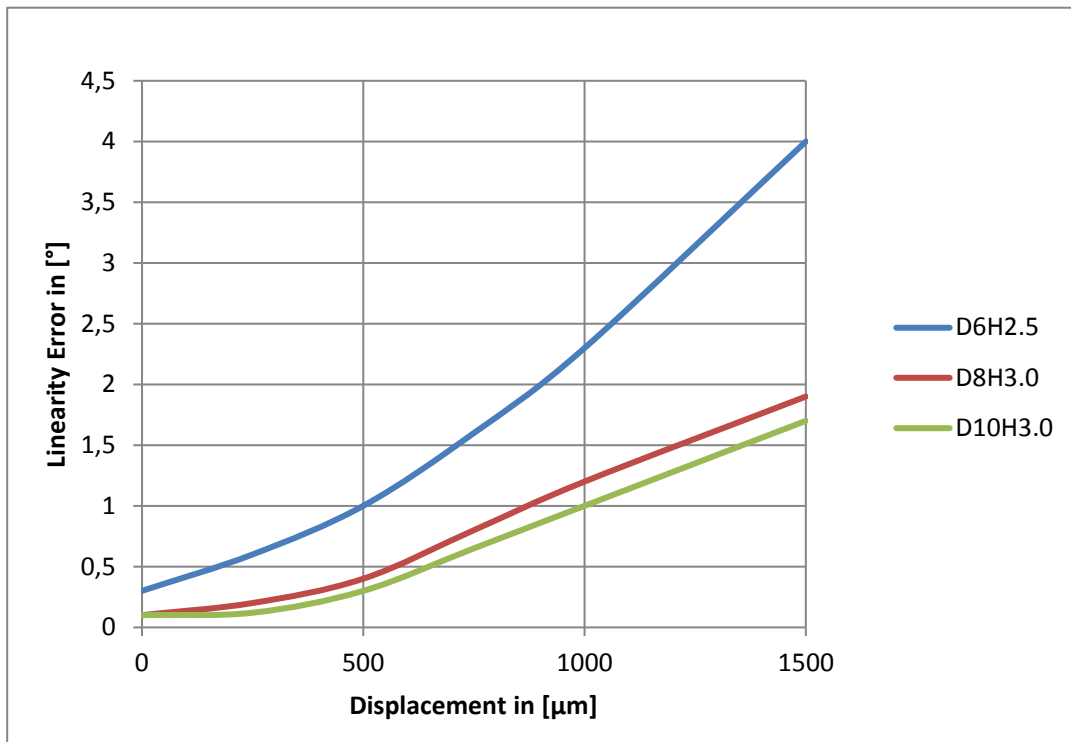

Figure 13 Non-Linearity error over displacement

Figure 13 shows the improvement by selecting 8 mm or 10 mm magnets. The error at best aligned case is improved as well.

## 2 Magnets

### 2.1 Magnet materials

Table 3 Magnet materials and properties

| Property                | Hard Ferrite  | Neodymium Iron Boron (NdFeB)  | Samarium Cobalt (SmCo)   |
|-------------------------|---|---|--|
|                         |  |  Preferred |  |
| Temperature Coefficient | -0.20%/°K   | -0.12%/°K   | -0.03%/°K  |
| Remanence Br            | 0.2 - 0.4 T   | 1.02 - 1.46 T   | 0.86 - 1.18 T  |
| Use Case MPS            | Special<br>(low cost / low performance )  | Standard<br>Industrial and Automotive   | Special<br>high temp. application  |

### 2.2 Magnet dimensions

Table 4 Possible magnet dimensions

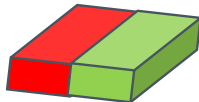
| Shape   | Size                                      |             |
|---|---|-------------|
| Cylinder<br> | Diameter = 6 mm<br>Thickness = 2.5 mm     | Recommended |
|   | Diameter = 8 mm<br>Thickness = 3 mm       |             |
|   | Diameter = 8 mm<br>Thickness = 4 mm       |             |
|   | Diameter = 10 mm<br>Thickness = 5 mm      |             |
| Square<br>   | Length/Width = 6 mm<br>Thickness = 2.5 mm |             |
|   | Length/Width = 8 mm<br>Thickness = 3 mm   |             |

## 2.2.1 Thickness increase of magnets

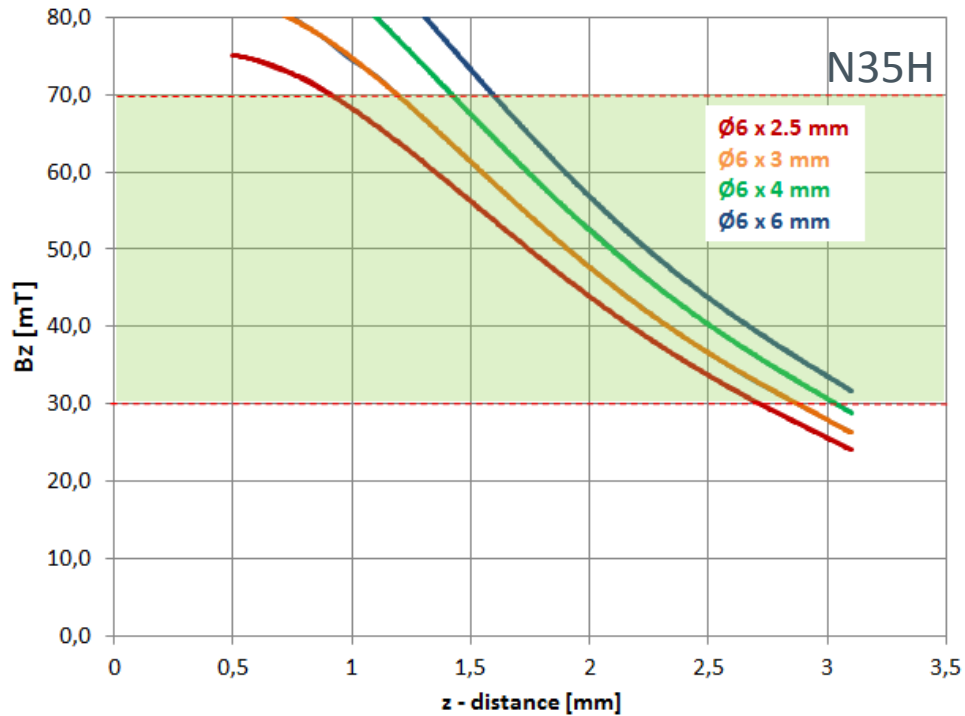

Figure 14 Magnetic Flux Density increases with increasing the magnet thickness (different magnets)

Figure 15 shows the relationship of the peak amplitude in a rotating system (essentially the magnetic field strength of the  $B_z$  field component) in relation to the thickness of the magnet. The X-axis shows the ratio of magnet thickness (or height) [H] to magnet diameter [D] and the Y-axis shows the relative peak amplitude with reference to the recommended magnet ( $D=6\text{mm}$ ,  $H=2.5\text{mm}$ ). The recommended magnet has H/D ratio of 0.42.

### Bz amplitude vs. magnet Thickness of a cylindrical diametric Magnet with 6mm Diameter

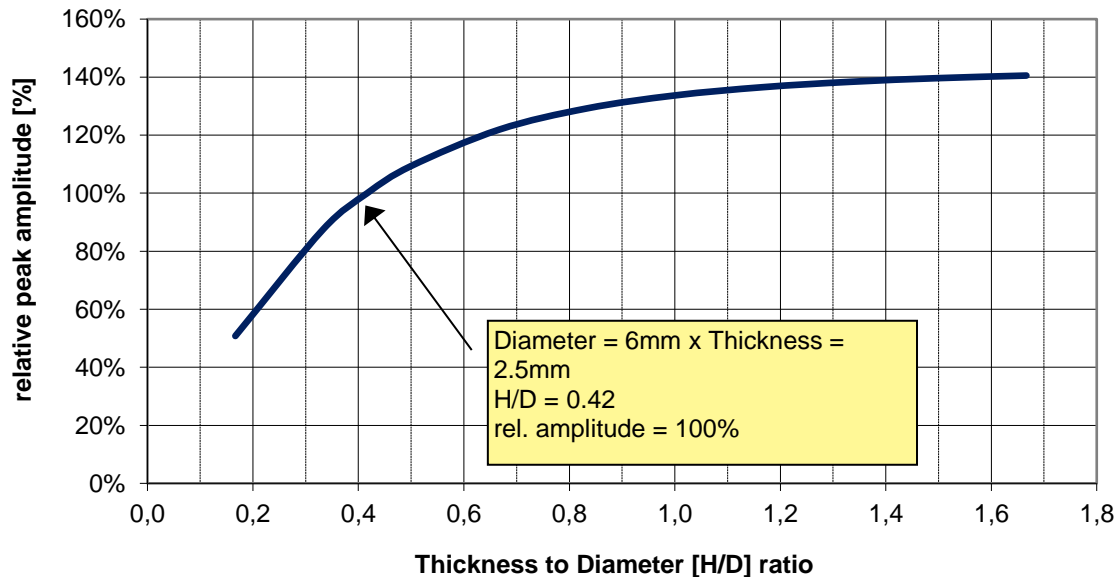

Figure 15 Thickness/Diameter Ratio

As the graph shows, the amplitude drops significantly at H/D ratios below this value and remains relatively flat at ratios above 1.3.

Therefore, the recommended thickness of 2.5mm (@6mm diameter) should be considered as the low limit with regards to magnet thickness.

It is possible to get 40% or more signal amplitude by using thicker magnets. However, the gain in signal amplitude becomes less significant for H/D ratios  $> \sim 1.3$ . Therefore, the recommended magnet thickness for a 6mm diameter magnet is between 2.5 and  $\sim 8$  mm.

## 2.2.2 Diameter increase of magnets

Table 5 Comparison of different magnet diameters 6 mm, 8mm and 10 mm

| Small diameter magnet (6mm):  | Large diameter magnet (8 mm, 10 mm):  |
|---|---|
| +++ stronger differential signal =<br>good signal / noise ratio,<br>larger air gaps | +++ wider linear range =<br>larger horizontal misalignment area                     |
| --- shorter linear range =<br>smaller horizontal misalignment area                  | -- weaker differential signal =<br>poorer signal / noise ratio,<br>smaller air gaps |

## 2.3 Magnetic grades

Both SmCo and NdFeB magnets are available in different grades, mainly determined by the remanence, essentially the strength of the magnet.

The recommended magnet grade for the magnetic position sensor when used for on-axis angle measurement is N35H for NdFeB magnets.

Note that NdFeB magnets have a lower operating temperature than SmCo magnets. A grade N35H has a maximum operating temperature of 120°C. If the magnet is to be operated at higher ambient temperatures, it is recommended to use a N35SH grade, which can operate up to 150°C

Table 6: SmCo magnet grades ([www.bomatec.ch](http://www.bomatec.ch))

| Quality         | Remanence      | Rev.temp.coeff. | Coercivity of field |                   | Rev.temp.coeff.     | Energy prod.                   | Max.op.temp. | Density                      |
|-----------------|----------------|-----------------|---------------------|-------------------|---------------------|--------------------------------|--------------|------------------------------|
|                 | Br             | of Br           | BHc                 | JHc               | of · c <sub>j</sub> | BH max.                        |              |                              |
| SmCo 2:17       | T<br>min./nom. | approx. %K      | kA/m<br>min./nom.   | kA/m<br>min./nom. | approx. %K          | kJ/m <sup>3</sup><br>min./nom. | approx. °C   | approx.<br>g/cm <sup>3</sup> |
| BMSG/24         | 0.95/1.02      | -0.032          | 700/730             | ≥1433             | -0.19               | 175/191                        | 300          | 8.3                          |
| BMSG/26         | 1.02/1.05      | -0.032          | 750/780             | ≥1433             | -0.19               | 191/207                        | 300          | 8.3                          |
| BMSG/28         | 1.03/1.08      | -0.032          | 756/796             | ≥1433             | -0.19               | 207/220                        | 300          | 8.3                          |
| BMSG/30         | 1.08/1.10      | -0.032          | 788/835             | ≥1433             | -0.19               | 220/240                        | 300          | 8.3                          |
| <b>BMSG/24H</b> | 0.95/1.02      | -0.032          | 700/730             | ≥1990             | -0.19               | 175/191                        | 300          | 8.3                          |
| BMSG/26H        | 1.02/1.05      | -0.032          | 750/780             | ≥1990             | -0.19               | 191/207                        | 300          | 8.3                          |
| BMSG/28H        | 1.03/1.08      | -0.032          | 756/796             | ≥1990             | -0.19               | 207/220                        | 300          | 8.3                          |
| BMSG/30H        | 1.08/1.10      | -0.032          | 788/835             | ≥1990             | -0.19               | 220/240                        | 300          | 8.3                          |

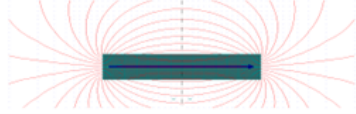
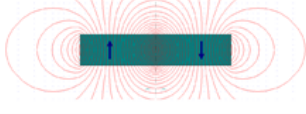
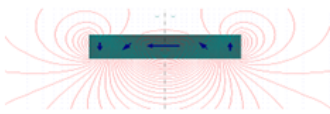

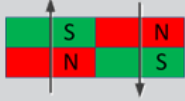
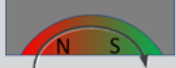

Table 7: NdFeB magnet grades ([www.bomatec.ch](http://www.bomatec.ch))

| Quality       | Remanence      | Rev.temp.coeff. | Coercivity of field |                   | Rev.temp.coeff. | Energy prod.                   | Max.op.temp. | Density                      |
|---------------|----------------|-----------------|---------------------|-------------------|-----------------|--------------------------------|--------------|------------------------------|
|               | Br             | of Br           | BHc                 | JHc               | of -cj          | BH max.                        |              |                              |
| NdFeB magnets | T<br>min./nom. | approx. %K      | kA/m<br>min./nom.   | kA/m<br>min./nom. | approx. %K      | kJ/m <sup>3</sup><br>min./nom. | approx. °C   | approx.<br>g/cm <sup>3</sup> |
| BMN-30H       | 1.08/1.14      | -0.11           | 780/812             | >1353             | -0.6            | 223/239                        | 120          | 7.5                          |
| BMN-33H       | 1.14/1.17      | -0.11           | 812/875             | >1353             | -0.6            | 239/263                        | 120          | 7.5                          |
| BMN-35H       | 1.17/1.21      | -0.11           | 836/891             | >1353             | -0.6            | 263/279                        | 120          | 7.5                          |
| BMN-38H*      | 1.22/1.26      | -0.11           | 859/915             | >1353             | -0.6            | 279/302                        | 120          | 7.5                          |
| BMN-40H*      | 1.26/1.3       | -0.11           | 859/915             | >1353             | -0.6            | 302/318                        | 120          | 7.5                          |
| BMN-42H*      | 1.3/1.33       | -0.11           | 859/915             | >1353             | -0.6            | 318/334                        | 120          | 7.5                          |
| BMN-45H*      | 1.33/1.37      | -0.11           | 859/915             | >1353             | -0.6            | 334/358                        | 120          | 7.5                          |
| BMN-46H*      | 1.35/1.38      | -0.11           | 859/915             | >1353             | -0.6            | 350/366                        | 120          | 7.5                          |
| BMN-48H*      | 1.37/1.41      | -0.11           | 859/915             | >1353             | -0.6            | 358/382                        | 120          | 7.5                          |
| BMN-27SH      | 1.02/1.06      | -0.11           | 780/812             | >1592             | -0.6            | 199/215                        | 150          | 7.5                          |
| BMN-30SH      | 1.08/1.14      | -0.11           | 780/812             | >1592             | -0.6            | 223/239                        | 150          | 7.5                          |
| BMN-33SH*     | 1.14/1.17      | -0.11           | 812/875             | >1592             | -0.6            | 239/263                        | 150          | 7.5                          |
| BMN-35SH*     | 1.17/1.22      | -0.11           | 836/891             | >1592             | -0.6            | 263/279                        | 150          | 7.5                          |
| BMN-38SH*     | 1.22/1.26      | -0.11           | 859/915             | >1592             | -0.6            | 279/302                        | 150          | 7.5                          |
| BMN-40SH*     | 1.26/1.3       | -0.11           | 859/915             | >1592             | -0.6            | 302/318                        | 150          | 7.5                          |
| BMN-42SH*     | 1.3/1.33       | -0.11           | 859/915             | >1592             | -0.6            | 318/334                        | 150          | 7.5                          |
| BMN-44SH*     | 1.33/1.36      | -0.11           | 859/915             | >1592             | -0.6            | 334/350                        | 150          | 7.5                          |
| BMN-28UH*     | 1.04/1.08      | -0.11           | 780/812             | >1989             | -0.6            | 199/223                        | 160          | 7.5                          |
| BMN-30UH*     | 1.08/1.14      | -0.11           | 796/844             | >1989             | -0.6            | 223/239                        | 160          | 7.5                          |
| BMN-33UH*     | 1.14/1.17      | -0.11           | 812/875             | >1989             | -0.6            | 239/263                        | 160          | 7.5                          |
| BMN-35UH*     | 1.17/1.22      | -0.11           | 836/891             | >1989             | -0.6            | 263/279                        | 160          | 7.5                          |
| BMN-38UH*     | 1.22/1.26      | -0.11           | 836/915             | >1989             | -0.6            | 279/302                        | 160          | 7.5                          |
| BMN-40UH*     | 1.26/1.30      | -0.11           | 836/915             | >1989             | -0.6            | 302/318                        | 160          | 7.5                          |
| BMN-28EH*     | 1.04/1.08      | -0.11           | 780/812             | >2387             | -0.6            | 199/223                        | 180          | 7.5                          |
| BMN-30EH*     | 1.08/1.14      | -0.11           | 796/844             | >2387             | -0.6            | 223/239                        | 180          | 7.5                          |
| BMN-33EH*     | 1.14/1.17      | -0.11           | 812/875             | >2387             | -0.6            | 239/263                        | 180          | 7.5                          |
| BMN-35EH*     | 1.17/1.22      | -0.11           | 836/915             | >2387             | -0.6            | 263/279                        | 180          | 7.5                          |
| BMN-38EH*     | 1.22/1.26      | -0.11           | 836/915             | >2387             | -0.6            | 279/302                        | 180          | 7.5                          |

## 2.4 Magnetization types

Table 8 Magnetization types

| Diametric Magnetization   | Axial Two-Pole Magnetization  | Surface Magnetization (one side)  |
|---|---|---|
|  |  |  |
|  |  |  |
| Standard  | Special   | Special   |
| Very good homogeneous Bz Field  | Medium homogeneous Bz Field   | Good homogeneous Bz Field   |
| Medium Strength in z- direction   | Very high Strength in z- Direction  | High Strength in z- Direction   |

Preferred

## 2.5 Magnetization errors

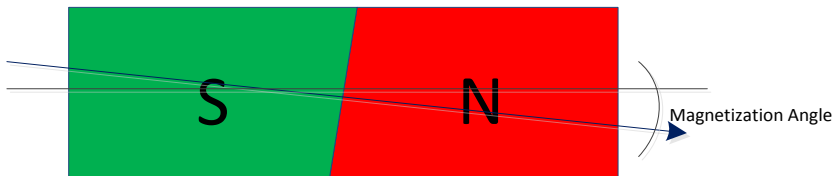

Figure 16 Magnetization angle

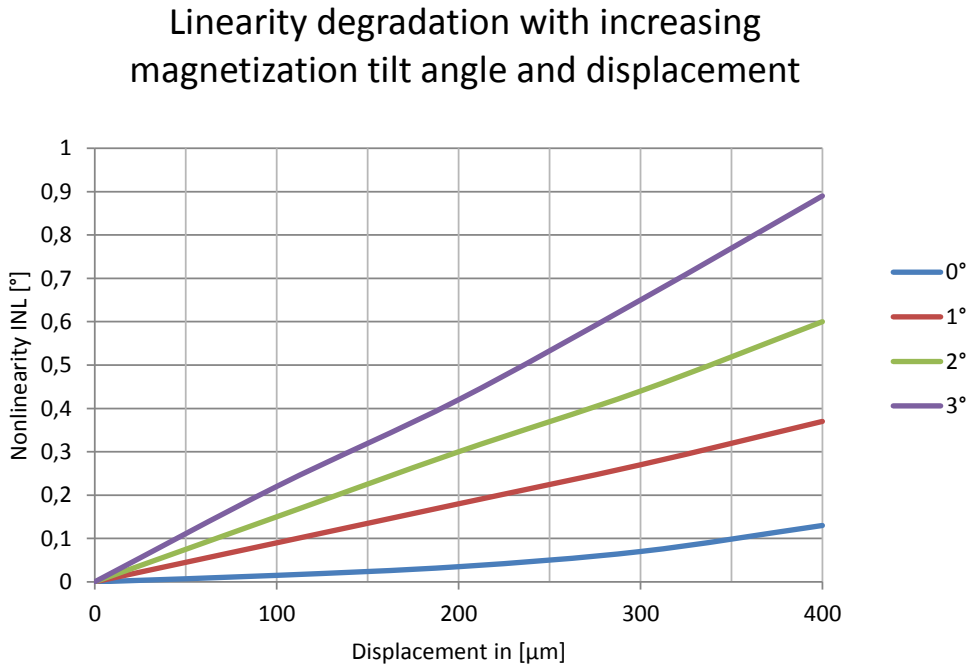

Figure 17 Magnetization tilt and impact to the INL parameter over displacement

### 2.6 Temperature effects on magnets

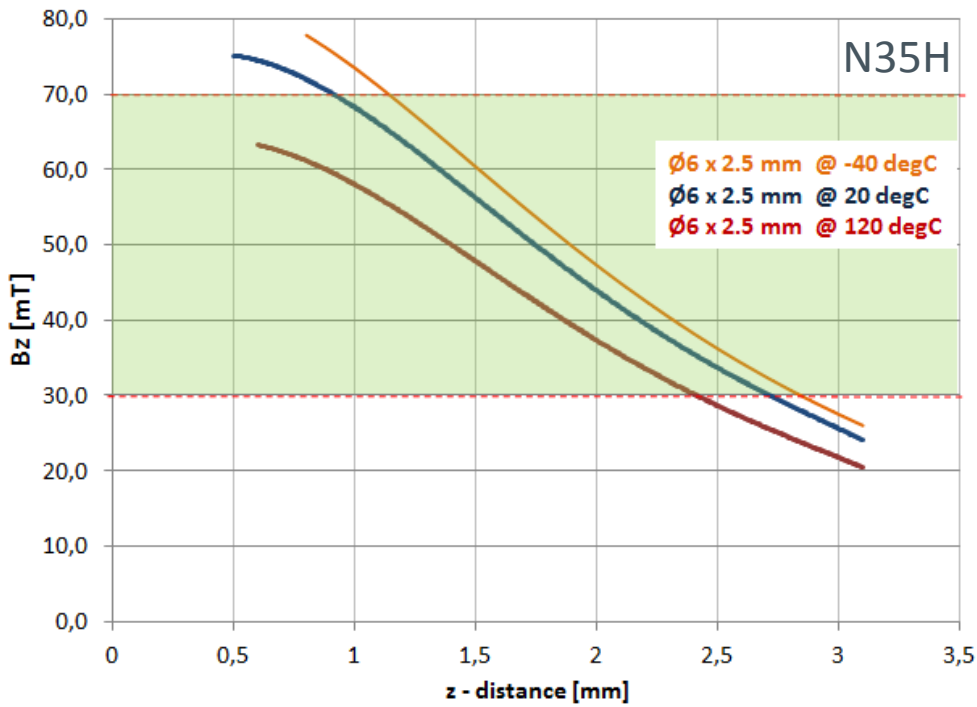

Figure 18: Magnetic flux density Bz of N35H magnet at different temperature (same magnet)

## 2.7 Mounting the magnet

Generally, for on-axis rotation angle measurement, the magnet must be mounted centred over the IC package. However, the material of the shaft on which the magnet is mounted, is also of utmost important.

Magnetic materials in the vicinity of the magnet will distort or weaken the magnetic field being picked up by the Hall elements and cause additional errors in the angular output of the sensor.

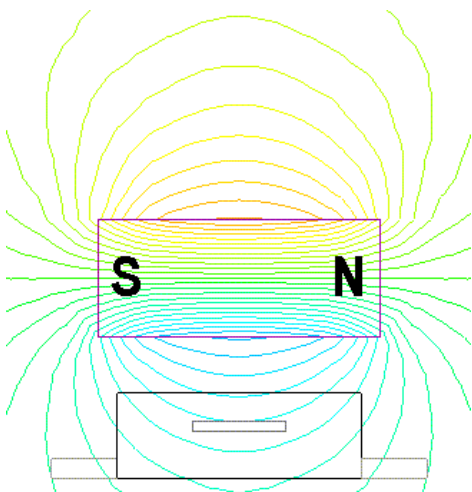

Figure 19 Magnetic field lines in air

Figure 19 shows the ideal case with the magnet in air. No magnetic materials are nearby.

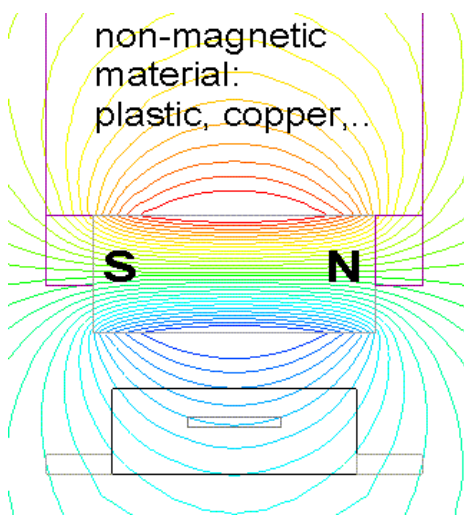

Figure 20 Magnetic field lines in plastic or copper shaft

If the magnet is mounted in non-magnetic material, such as plastic or diamagnetic material, such as copper, the magnetic field distribution is not disturbed.

Even paramagnetic material, such as aluminum may be used. The magnet may be mounted directly in the shaft.

Note: stainless steel may also be used, but some grades are magnetic, they should be avoided.

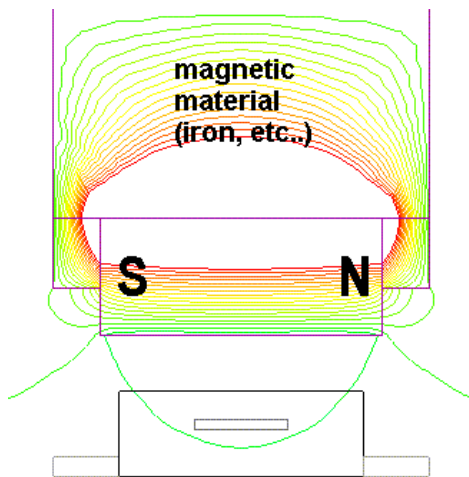

Figure 21 Magnetic field lines in iron shaft

If the magnet is mounted in a ferromagnetic material, such as iron, most of the field lines are attracted by the iron and flow inside the metal shaft (see Figure 21). The magnet is weakened substantially. This configuration should be avoided !!

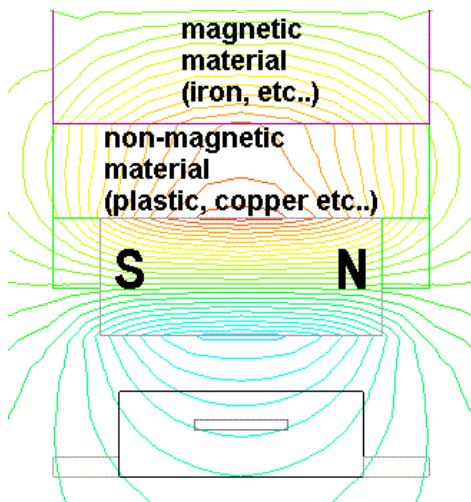











Figure 22 Magnetic field lines with spacer between magnet and iron shaft

If the magnet has to be mounted inside a magnetic shaft, a possible solution is to place a non-magnetic spacer between shaft and magnet, as shown in Figure 22. While the magnetic field is rather distorted towards the shaft, there are still adequate field lines available towards the sensor IC. The distortion remains reasonably low.

### 3 Magnet suppliers

Table 9 Magnet supplier for Position Sensor Products

|   | Preferred Suppliers                  | Link  | Contact  |
|---|--------------------------------------|---|--|
|    | AIC Engineering Limited              | <a href="http://www.aicengineering.com">www.aicengineering.com</a>                | <a href="http://www.aicengineering.com">www.aicengineering.com</a>                                   |
|    | Alliance LLC                         | <a href="http://www.allianceorg.com">www.allianceorg.com</a>                      | <a href="http://www.allianceorg.com/contactus.html">www.allianceorg.com/contactus.html</a>           |
|    | Arnold Magnetic Technologies         | <a href="http://www.arnoldmagnetics.com">www.arnoldmagnetics.com</a>              | <a href="http://www.arnoldmagnetics.com/Contact.aspx">www.arnoldmagnetics.com/Contact.aspx</a>       |
|    | Bomatec AG                           | <a href="http://www.bomatec.ch">www.bomatec.ch</a>                                | <a href="http://www.bomatec.ch/standorte.html">www.bomatec.ch/standorte.html</a>                     |
|    | Dexter Magnetic Technologies         | <a href="http://www.dextermag.com">www.dextermag.com</a>                          | <a href="http://www.dextermag.com/Offices">www.dextermag.com/Offices</a>                             |
|    | Magnetfabrik Bonn                    | <a href="http://www.magnetfabrik.de">www.magnetfabrik.de</a>                      | <a href="http://www.magnetfabrik.de/kontakt.php">www.magnetfabrik.de/kontakt.php</a>                 |
|    | Mittelland Magnets                   | <a href="http://www.mittelland-magnets.com">http://www.mittelland-magnets.com</a> | <a href="http://www.mittelland-magnets.com/contact.html">www.mittelland-magnets.com/contact.html</a> |
|  | MS-Schramberg GmbH & Co KG           | <a href="http://www.magnete.de">www.magnete.de</a>                                | <a href="http://www.magnete.de/kontakt.html">www.magnete.de/kontakt.html</a>                         |
|  | Zhejiang Innuovo Magnetics Co., Ltd. | <a href="http://www.magnet-innuovo.com">www.magnet-innuovo.com</a>                | <a href="http://www.magnet-innuovo.com/Contact.asp">http://www.magnet-innuovo.com/Contact.asp</a>    |

#### 3.1 Magnets on AMS web shop

Table 10 Available magnets on AMS web shop

| Part No.      | Description  | Magnetization    | Size     | Material | max temp. | Others                        |
|---------------|--|------------------|----------|----------|-----------|-------------------------------|
| AS5000-MD6H-1 | Diametric Magnet, D6x2.5mm, Arnold Magnetic                      | Diametric Magnet | D6x2.5mm | NdFeB    | 120°C     |                               |
| AS5000-MD6H-2 | Diametric Magnet, D6x2.5mm, Bomatec AG                           | Diametric Magnet | D6x2.5mm | NdFeB    | 120°C     |                               |
| AS5000-MD6H-3 | Diametric Magnet, D6x2.5mm, Dexter Magnetics                     | Diametric Magnet | D6x2.5mm | NdFeB    | 120°C     |                               |
| AS5000-MD6H-4 | Diametric Magnet, D6x2.5mm, Mittelland Magnets                   | Diametric Magnet | D6x2.5mm | NdFeB    | 120°C     | < 3° Tilt magnetization error |
| AS5000-MD6H-5 | Diametric Magnet, D6x2.5mm, AIC Engineering Limited              | Diametric Magnet | D6x2.5mm | NdFeB    | 120°C     | < 3° Tilt magnetization error |
| AS5000-MD6H-6 | Diametric Magnet, D6x2.5mm, Zhejiang Innuovo Magnetics Co., Ltd. | Diametric Magnet | D6x2.5mm | NdFeB    |           | < 3° Tilt magnetization error |

| Part No.       | Description  | Magnetization    | Size     | Material | max temp. | Others                        |
|----------------|--|------------------|----------|----------|-----------|-------------------------------|
| AS5000-MD6SH-1 | Diametric Magnet, D6x2.5mm, Alliance LLC                         | Diametric Magnet | D6x2.5mm | NdFeB    | 150°C     |                               |
| AS5000-MD8H-1  | Diametric Magnet, D8x2.5mm, Bimatec AG                           | Diametric Magnet | D8x2.5mm | NdFeB    | 120°C     |                               |
| AS5000-MD8H-2  | Diametric Magnet, D8x2.5mm, AIC Engineering Limited              | Diametric Magnet | D8x2.5mm | NdFeB    | 120°C     | < 3° Tilt magnetization error |
| AS5000-MD8H-3  | Diametric Magnet, D6x2.5mm, Zhejiang Innuovo Magnetics Co., Ltd. | Diametric Magnet | D8x2.5mm | NdFeB    |           | < 3° Tilt magnetization error |

## 4 Contact Information

**Buy our products or get free samples online at:**

[www.ams.com/ICdirect](http://www.ams.com/ICdirect)

**Technical Support is available at:**

[www.ams.com/Technical-Support](http://www.ams.com/Technical-Support)

**Provide feedback about this document at:**

[www.ams.com/Document-Feedback](http://www.ams.com/Document-Feedback)

**For further information and requests, e-mail us at:**

[ams\\_sales@ams.com](mailto:ams_sales@ams.com)

**For sales offices, distributors and representatives, please visit:**

[www.ams.com/contact](http://www.ams.com/contact)

### Headquarters

ams AG

Tobelbaderstrasse 30

8141 Unterpremstaetten

Austria, Europe

Tel: +43 (0) 3136 500 0

Website: [www.ams.com](http://www.ams.com)



## 5 Copyrights & Disclaimer

Copyright ams AG, Tobelbader Strasse 30, 8141 Unterpremstaetten, Austria-Europe. Trademarks Registered. All rights reserved. The material herein may not be reproduced, adapted, merged, translated, stored, or used without the prior written consent of the copyright owner.

Information in this document is believed to be accurate and reliable. However, ams AG does not give any representations or warranties, expressed or implied, as to the accuracy or completeness of such information and shall have no liability for the consequences of use of such information.

Applications that are described herein are for illustrative purposes only. ams AG makes no representation or warranty that such applications will be appropriate for the specified use without further testing or modification. ams AG takes no responsibility for the design, operation and testing of the applications and end-products as well as assistance with the applications or end-product designs when using ams AG products. ams AG is not liable for the suitability and fit of ams AG products in applications and end-products planned.

ams AG shall not be liable to recipient or any third party for any damages, including but not limited to personal injury, property damage, loss of profits, loss of use, interruption of business or indirect, special, incidental or consequential damages, of any kind, in connection with or arising out of the furnishing, performance or use of the technical data or applications described herein. No obligation or liability to recipient or any third party shall arise or flow out of ams AG rendering of technical or other services.

ams AG reserves the right to change information in this document at any time and without notice.

## 6 Revision Information

| Changes from previous version to current revision 1-04 (2016-Sep-28)                              | Page |
|---|------|
| V1.03: Innuovo Contact Information updated  |      |
| V1.02: new magnets added: AS5000-MD8H-2; AS5000-MD8H-3; AS5000-MD6H-5; AS5000-MD6H-6              | 23   |
| V1.01: Additional information about INL over z-distance AS5600, AS5601, AS5047P, AS5147P included |      |
| Initial version 1-00  |      |

**Note:** Page numbers for the previous version may differ from page numbers in the current revision.  
Correction of typographical errors is not explicitly mentioned.