



austriamicrosystems AG

is now

ams AG

The technical content of this austriamicrosystems document is still valid.

Contact information:

Headquarters:

ams AG
Tobelbaderstrasse 30
8141 Unterpremstaetten, Austria
Tel: +43 (0) 3136 500 0
e-Mail: ams_sales@ams.com

Please visit our website at www.ams.com

AS5013-DB-1.1

Lower Power Integrated Hall IC for Human Interface Applications

Demoboard and Software
Operation Manual

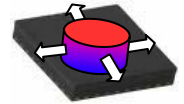

1 General Description

The AS5013 is a complete Hall Sensor IC for smart navigation key applications to meet the low power requirements and host SW integration challenges for products such as cell phones and smart handheld devices. Due to the on chip processing engine, system designers are not tasked with integrating complex SW algorithms on their host processor thus leading to rapid development cycles.

The AS5013 single-chip IC includes 5 integrated Hall sensing elements for detecting up to $\pm 2\text{mm}$ lateral displacement, high resolution ADC, XY coordinate and motion detection engine combined with a smart power management controller.

The X and Y positions coordinates and magnetic field information for each Hall sensor element is transmitted over a 2-wire I²C interface to the host processor.

The AS5013 is available in a small 16-pin 4x4mm QFN package and specified over an operating temperature of -20 to +80°C.

2 The AS5013 Demoboard

The AS5013 demoboard consists of an EasyPoint™ module N40P105 from Wintec Technology (<http://www.wintectechnology.com/>) and an USB interface PCB. The whole system is USB powered.

Once plugged on a PC running Windows, the AS5013 demoboard works like a standard two-buttons analog HID joystick, and can be used by any game or application supporting two-axis analog joysticks under Microsoft Windows.

Figure 1. AS5013-DB Demoboard



Figure 2. AS5013 Demoboard, technical description

**EasyPoint N40P106 module:**

Moving the knob of the EasyPoint module acts like an analog joystick, sending progressive XY coordinates to Windows via USB.

Button I (EasyPoint module push):

The joystick 1 is emulated by pushing the module's knob vertically. This knob is used as the left mouse button when using the mouse emulator of the AS501x Evaluation Software.

Button II:

This switch emulates the second joystick button, or the right mouse button when using the Evaluation Software.

Calibration:

In order to compensate an inaccurate centering of the module's knob, an automatic centering calibration is performed each time the demoboard is plugged on the PC.

The calibration procedure can be manually done by clicking the **Calibration** knob on the demoboard: a new zero position will be set, the actual mechanical position of the knob is considered as the coordinate (0,0).

Three function LEDs are present on the USB interface, but one only is effective, the **Center LED** which indicates that the knob is centered on the calibrated (0,0) position.

3 First Time Installation

As the AS5013 Demoboard works like a standard HID mouse, no software is needed to test it. But for more flexibility and in order to become familiar with the principle of the AS5013 sensor, the *AS5013 Mouse GUI* software allows to modify the device registers, read the magnet coordinates and change some attribute of the mouse.

In order to get started, you need:

- The *AS501x Evaluation Software* GUI installer
- a Windows XP® or Windows Vista® operating system
- one free USB slot on your PC to connect the demoboard

The *AS501x Evaluation Software* is available on the following link:

<http://www.austriamicrosystems.com/eng/Support/Design-Resources/Demo-Eval.-Progr.-Boards/EasyPoint-Linear-Encoder/EasyPoint-AS5013-DB-Demoboard>

Before plugging the demoboard on the PC, execute the *AS501x Evaluation Software* installer, and follow the instructions. Once the installation is complete, plug the AS5013 demoboard into the PC with the USB cable.

If it is the first time the AS5013 demoboard is connected on the computer, Windows may look for a driver. This one can be found in the following directory:

<C:\Program Files\ austriamicrosystems \ AS501x Evaluation Software \ USB Driver>

Once the installation is completed, start the software. If it is the first time it has been installed, you will be required to start the calibration (standard Windows procedure).

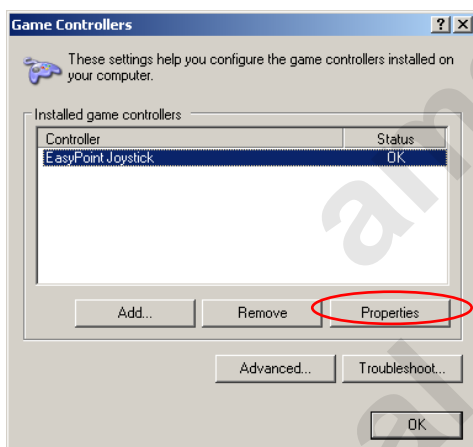

EasyPoint Joystick should be present, select **Properties**

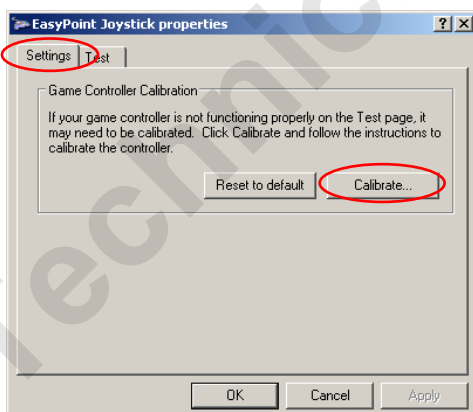

Select **Settings** tab then **Calibrate**

Now Follow the instructions:

Center the joystick (release it) and click **Next**.

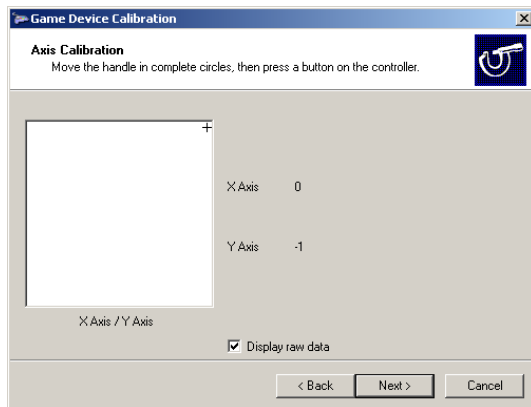

Do **circular movements** of the joystick with maximum amplitude.

Click **Next** until the end of the procedure.

Center the joystick again (release it) and click **Next**.

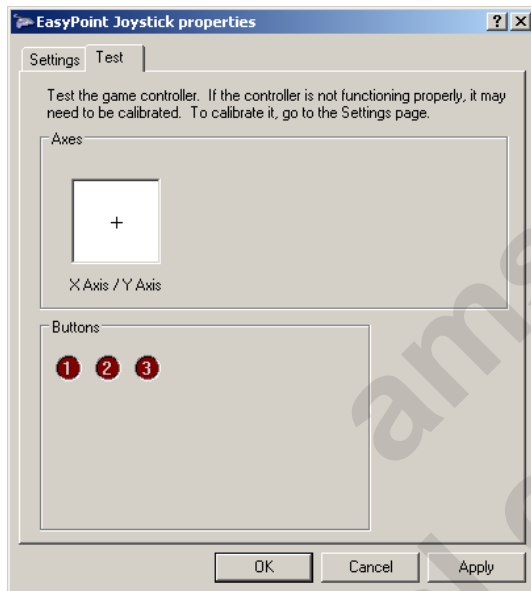

Select the **Test** tab. The cursor on the screen should now follow the position of the knob, and must reach the four edges of the square. If the knob is released, the cursor should be positioned on the center of the square.

Pushing the module's knob vertically activates the **button 1** indicator.
Pushing Joystick Button II on the board activates the **button 2** indicator.
Button 3 indicator is not used.

Once the calibration finished and verified, click on OK to exit the configuration mode.

Now the joystick is fully operational, and can be used by any Windows program supporting a joystick, or by the AS5013 Evaluation Software (see next chapter).

Note

The calibration has to be done only the first time the demoboard is plugged into the PC.

If the demoboard has been changed, a new calibration must be performed.

The link to the Joystick Calibration window can be found in the main window menu **Setup**.

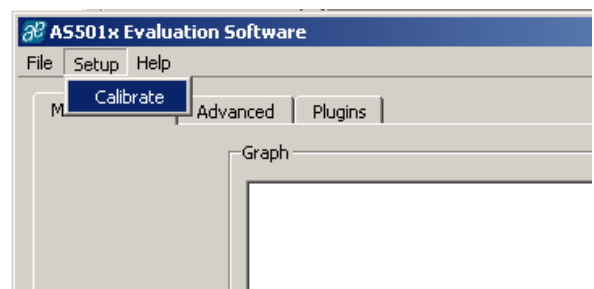

4 AS5013 Evaluation Software

Once the AS5013-DB demoboard has been correctly calibrated, the evaluation can start. The software has three tabs:

- Mouse Control
- Advanced
- Plugins

4.1 Mouse Control Tab

The AS5013 Evaluation Software includes a mouse emulator, enabled by default. Moving the knob on the demoboard will control the mouse with progressive speed: small knob movements will move the mouse slowly, large mouse movements will move the mouse with a high speed velocity.

The left mouse click is emulated by Button 1, and right mouse click by Button 2.

Figure 3. Mouse Control Tab

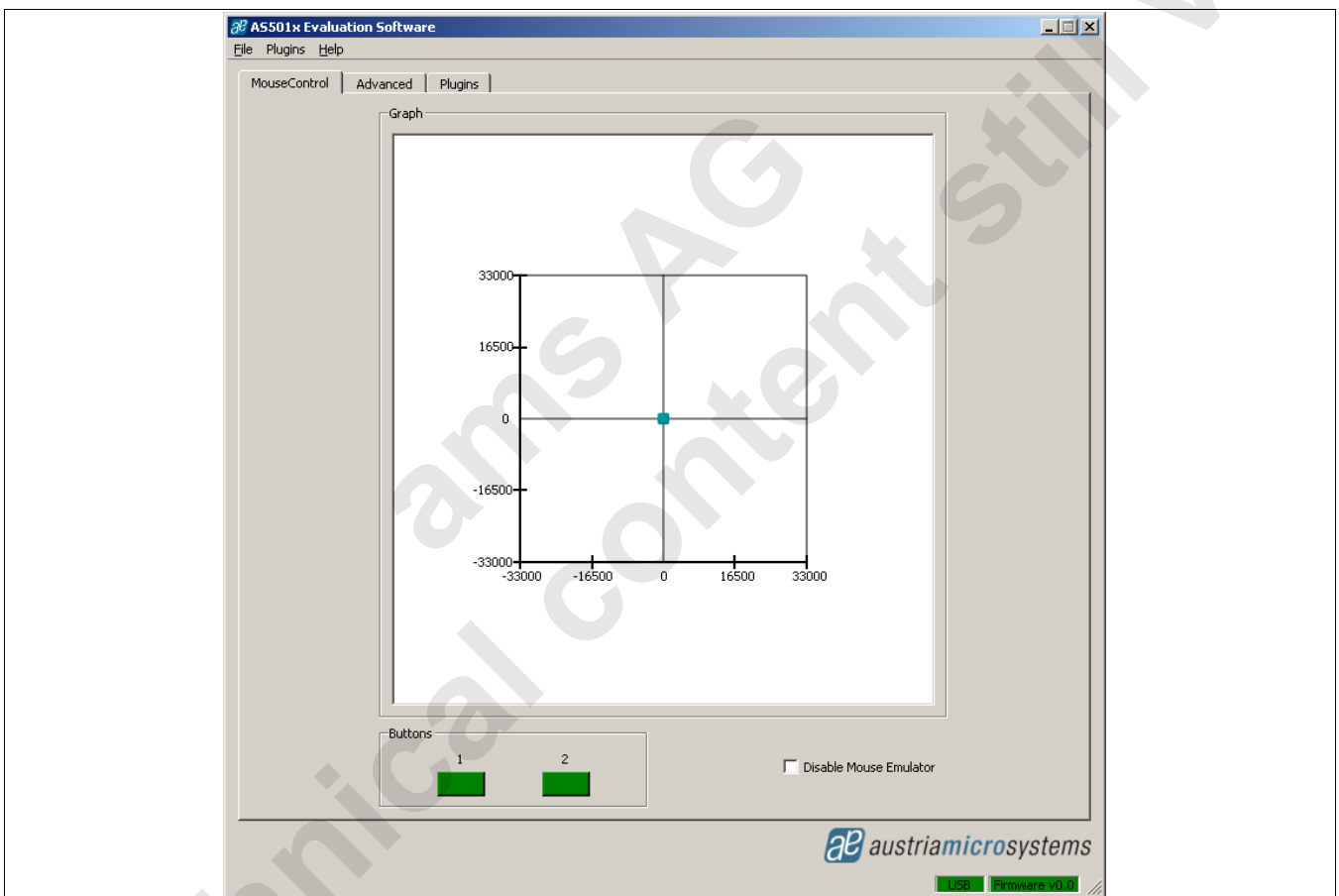

Graph: Shows the position of the knob graphically from the HID XY data (standard joystick coordinates). The range -33,000 ~ +33,000 is the translation from EasyPoint coordinates (8-bit) to Windows HID driver (16-bit).

Disable Mouse Emulator: Checking this box will disable the mouse emulator.

4.2 Advanced Tab

This tab gives access to advanced controls:

- Mouse emulator control
- I²C register access to AS5013 registers
- Firmware controls of the demoboards MCU

Figure 4. Advanced Tab

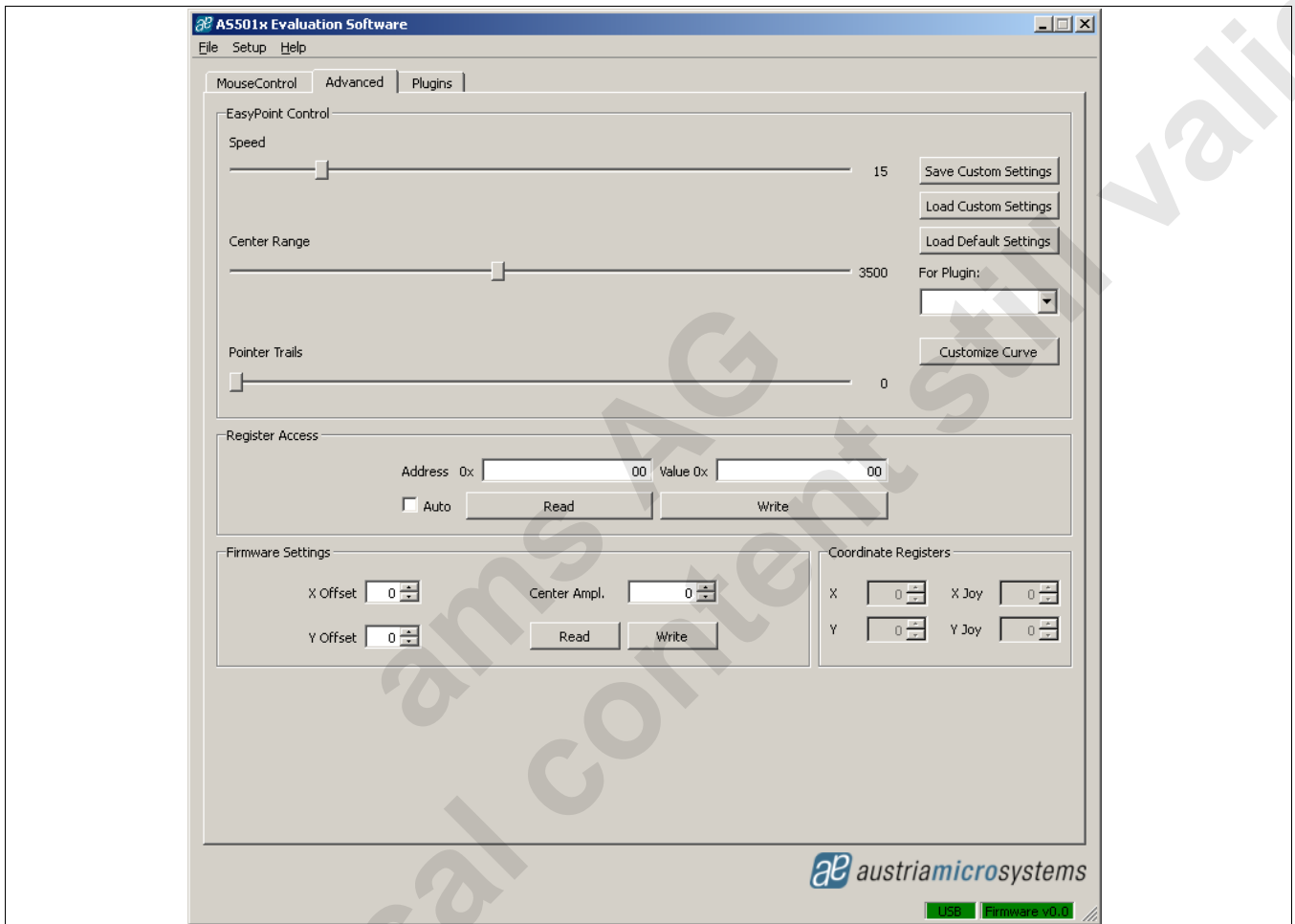

EasyPoint control:

This part controls the software mouse emulator.

- **Speed** can be increased by changing the Speed control.
- **Center Range** controls the radius around the center position, where the mouse does not move (dead zone).
- **Pointer Trails** will add shading pointers following the main mouse pointer.
- **Save Custom Settings**: Save the actual mouse setting into a .ini file.
- **Load Custom Settings**: Load any mouse setting (.ini file), and sets automatically the Speed, Center Range and Pointer Trails with those saved settings.
- **Load Default Settings**: Different mouse settings can be assigned independently to each plugin (see next chapter "Plugin Tab"). Select a plugin in the "For Plugin" field, before clicking on this button. Blank is for the default mouse settings.

- **Customize Curve:**

The mouse response can be fully parameterized with a look-up table.

X-axis is the module knob displacement (range 0 to 10)

Y-axis is the translated value sent to the mouse emulator.

A curve is created independently for each plugin, and can be modified to optimize the user's experience:

1. Select the plugin for which the response has to be displayed or modified. Blank plugin is the default mouse curve.
2. Click on **Load Default Curve**
3. A new curve corresponding to the plugin has been loaded

Figure 5. Curve Generator Window

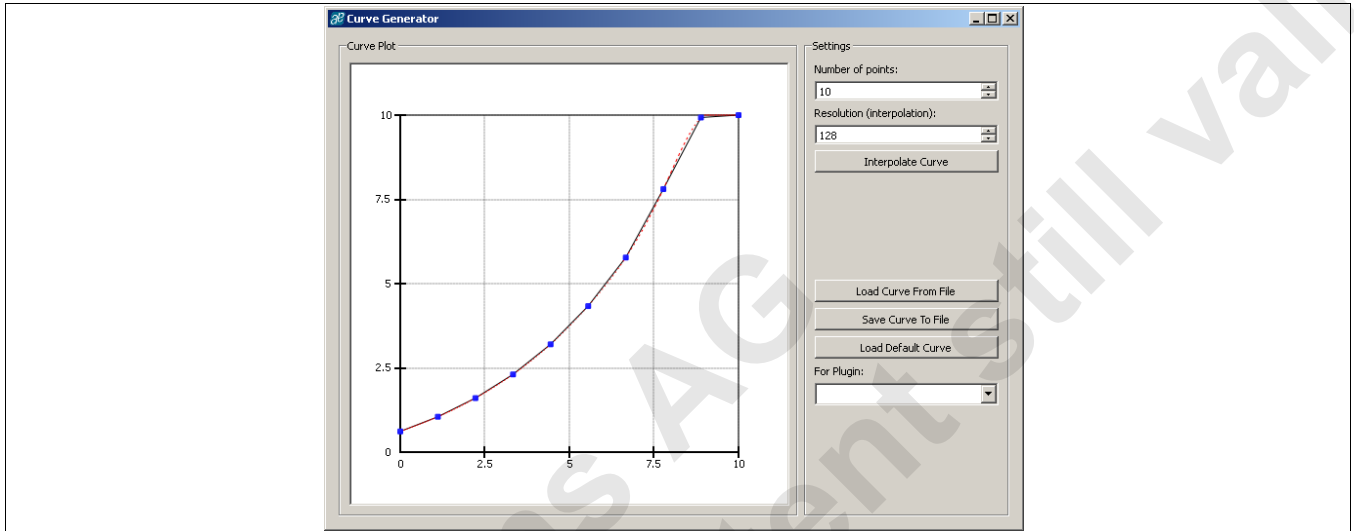

4. Drag the blue points vertically on the curve to modify its shape
5. Once finished, click on **Interpolate Curve**
6. Save the final curve into a .ini file. This file can be recalled anytime when executing a plugin (see chapter 4.3)

The number of blue points on the curve can be increased in order to get a more precise control curve.

Interpolate curve smoothes and validates the curve after modification with the blue points, before saving it. The number of interpolation points can be changed.

Register Access:

The AS5013 I²C registers can be read and written from this box, by entering hex address of the register and the hex value to write.

The *Auto* checkbox enables the automatic periodic readout of the register pointed in the address box.

Coordinates Registers:

- **X, Y** (signed byte): Direct X and Y register values from the AS5013 (Registers 10h and 11h).
- **X Joy, Y Joy** (signed byte): Corrected (zero position offset added) XY coordinates sent to the Windows HID driver before calibration. The zero position offset values are described in "Mouse Adjustments" below.

Firmware Settings:

- **X Offset / Y Offset** (signed byte): Is the offset added to the X and Y registers to obtain X Joy / Y Joy. The offset values are computed when the demoboard is powered up, to compensate an eventual mechanical misalignment of the knob at the zero position. The calculation of X Joy (the same is applied for Y Joy): $X\ Joy = (X + X\ Offset)$
- **Center Ampl.:** Controls the dead zone area width around the zero position. Used only for the LED control on the demoboard.

The values of X Offset / Y Offset and Center Ampl. Can be read and written by clicking on the corresponding buttons.

4.3 Plugins Tab

Plugins are applications using the potential of EasyPoint modules and AS5013.

Each plugin has a personalized look-up-table (response curve), by clicking on the corresponding **Customize** button. See Chapter 4.2, “Customize Curve” for more information.

Figure 6. Plugins Tab

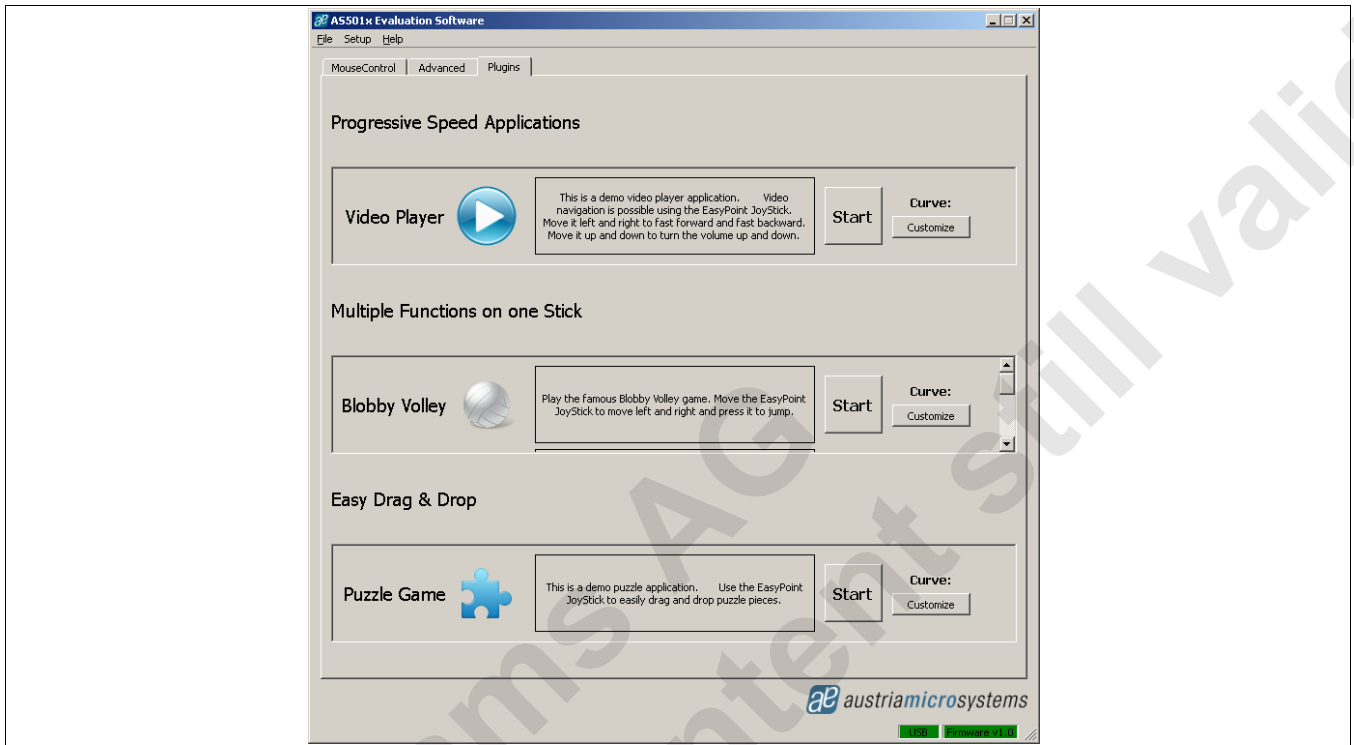

Three categories of plugins are available:

- **Progressive speed applications**
This plugin type shows the advantages of having an analog control on X and Y axis, to control progressively e.g. position cursors.
- **Multiple Functions on one Stick**
This plugin type shows the advantage of the progressive speed applications combined with a push button. Those applications are typically games or navigation controls.
- **Easy Drag & Drop**
This plugin type shows the possibility to use the drag & drop function with EasyPoint modules: Click and hold down the knob of the module, while moving an object, then drop it to an other place by releasing the knob.

4.3.1 Progressive Speed Applications

- **Video Player:**

This simple video player can open any .avi, .mpg, .mov, .wmv video file and play it.

Progressive Video Speed control:

Moving the EasyPoint button to **left** or **right**, the movie will do a FFW or RWD with a speed of 2x to 64x, depending on the button **horizontal** position.

Progressive Volume control:

Moving the EasyPoint button to **up** or **down**, the volume will increase or decrease. The speed of the volume button is progressive with the EasyPoint knob's **vertical** position.

4.3.2 Multiple Functions on one Stick

- **Blobby Volley**

Simple volley game using left and right movement for moving the green blob, push button to jump.

- **Briguolo**

Brick arcade game, using the progressive left-right movement of the module will move the racket progressively from slowly (low amplitude of the knob) to quickly (high amplitude of the knob)

- **EasyPoint Navigation:**

Picture viewer with scrolling and zoom functions. This application shows the features of EasyPoint for applications such as GPS maps navigation.

The default picture can be changed anytime by clicking on the button Open Image

Progressive Multidirectional Scrolling:

Progressive speed and smooth directions and angles are used to move the map to any direction.

Progressive Zoom-in / Zoom-out

Pushing the **EasyPoint knob** and SIMULTANEOUSLY moving it **up** or **down** will zoom-out/zoom-in the picture. The speed of the zoom is progressive, depending on the knob's amplitude.

Progressive Picture Rotation

Pushing the **Button II** and SIMULTANEOUSLY moving it **left** or **right** will rotate the picture with a progressive speed depending on the knob's amplitude.

4.3.3 Easy Drag & Drop

- **Puzzle Game**

Drag and drop function: pick a part of the austriamicrosystems logo, push the knob, and move the part into the grid WITHOUT releasing the knob. To drop the item into the wanted place, release the knob.

To help the user in the game, a correct position of the puzzle tile is indicated by a green background, and a wrong position with a blue background.

Figure 7. Puzzle game, correct tile placement

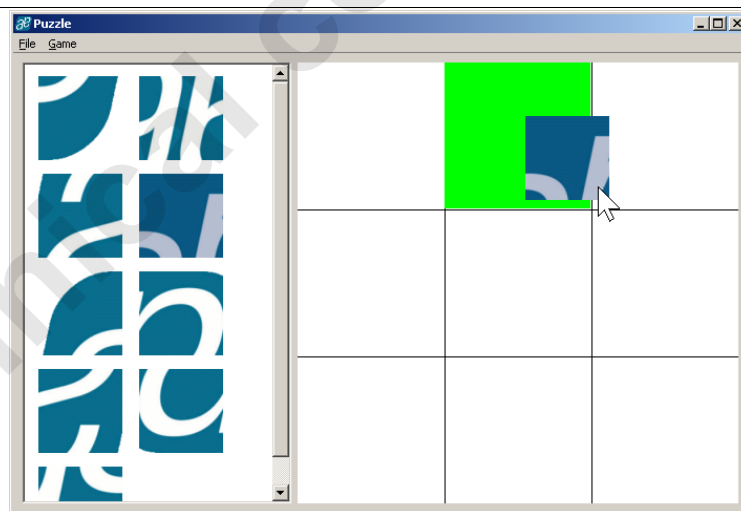

5 AS5013 Demoboard Hardware

5.1 Schematics

Figure 8. AS5013_DB_1.1 Schematics

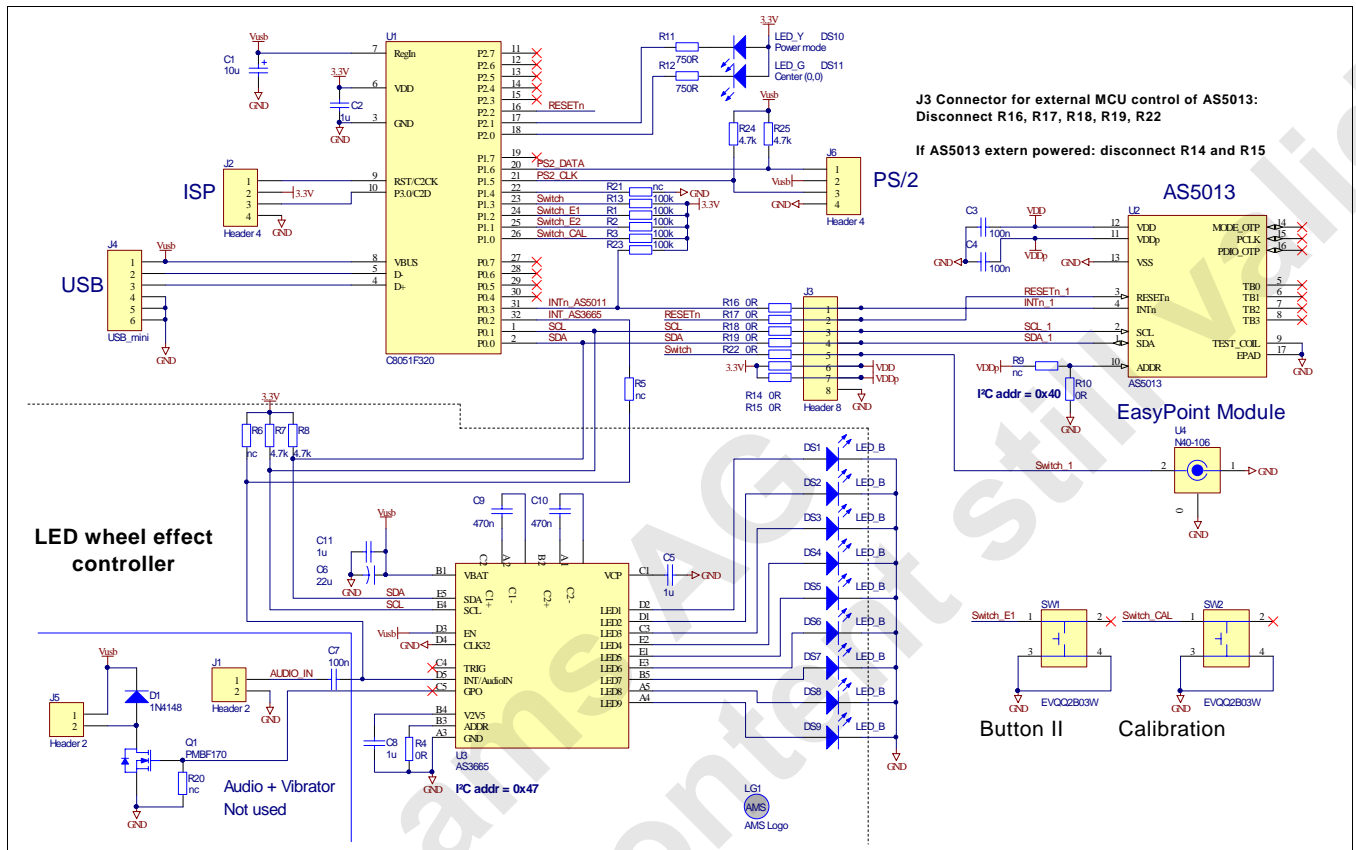

The microcontroller C8051C320 (U1) from SiLabs includes an on-chip USB interface. The firmware is stored in its internal flash memory (16kB).

The whole power supply is taken from the USB bus by the microcontroller, and converts it internally to 3.3V. No external LDO is required. The AS5013 is directly powered (VDD and VDDp) by this 3.3V supply.

Connector J3 is used if an external MCU has to be connected to the AS5013 of the demoboard, instead of the C8051F320. In that case, resistors R16, R17 (I²C bus) and R9 have to be removed in order to disconnect the on-board MCU.

Connectors J1 J5 J6 are not used.

Connector J2 is used for ISP programming of the microcontroller only.

All the switches (dome switch: Button I, SW1: Button II, SW2: Calibration button) are connected directly to the microcontroller.

The unique I²C serial bus (SCL, SDA) controlled by the C8051 microcontroller is used for:

- AS5013
- AS3665, LED management unit

The interrupt output INTn is connected directly to the interrupt input the MCU.

Note:

The AS5013 combined with N40P106 modules can be connected to an external microcontroller for test purposes. Disconnect R16, R17, R18, R19, R22, and connect the external microcontroller on J3. If the AS5013 is externally powered, disconnect R14 and R15.

5.2 Layout

Figure 9. PCB Top View

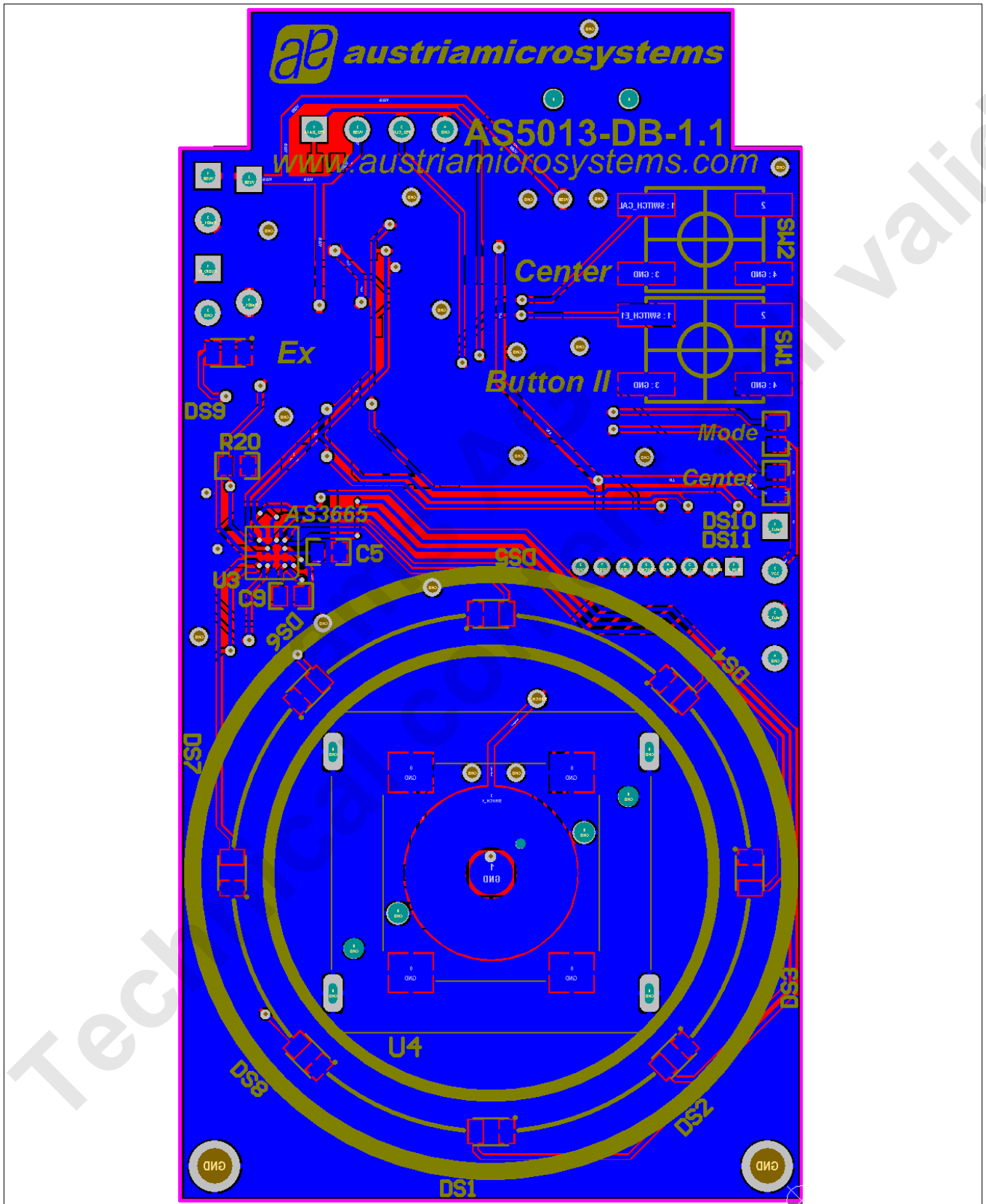
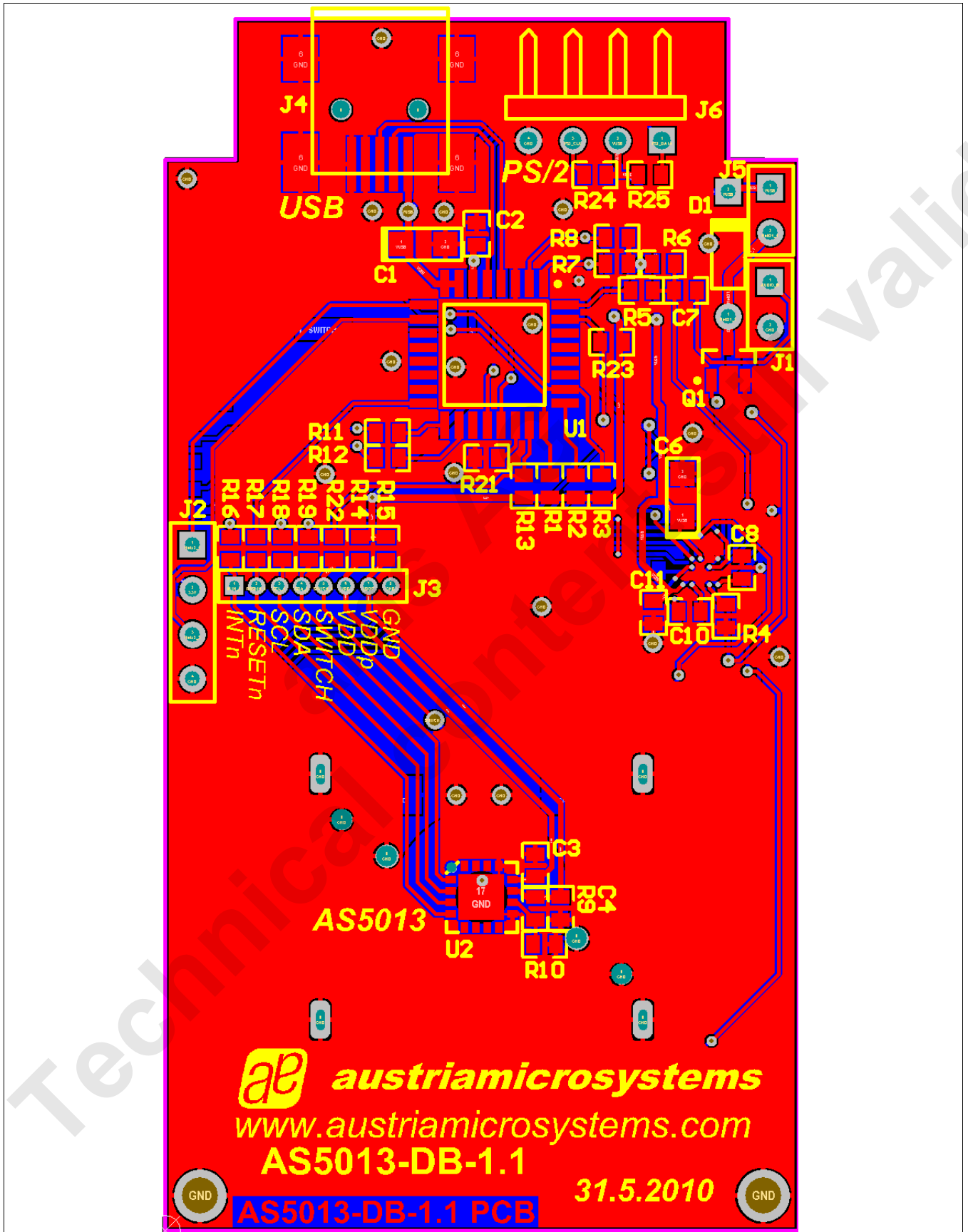

Figure 10. PCB Bottom View



6 Internet Website References

austriamicrosystems EasyPoint website, general information about AS5013 and EasyPoint modules:
<http://www.austriamicrosystems.com/eng/Products/Magnetic-Encoders/EasyPoint-Joystick-Encoder>

AS5013-DB demoboard information and software:

<http://www.austriamicrosystems.com/eng/Support/Design-Resources/Demo-Eval.-Progr.-Boards/EasyPoint-Linear-Encoder/EasyPoint-AS5013-DB-Demoboard>

Wintech Technology, EasyPoint modules manufacturer:

<http://www.wintechtechnology.com/>

7 Table of Contents

1	General Description	1
2	The AS5013 Demoboard	1
3	First Time Installation	3
4	AS5013 Evaluation Software.....	5
4.1	Mouse Control Tab.....	5
4.2	Advanced Tab.....	6
4.3	Plugins Tab.....	8
4.3.1	Progressive Speed Applications	8
4.3.2	Multiple Functions on one Stick.....	9
4.3.3	Easy Drag & Drop	9
5	AS5013 Demoboard Hardware	10
5.1	Schematics	10
5.2	Layout.....	11
6	Internet Website References.....	13
7	Table of Contents	13

Revision History

Table 1. Revision History

Revision	Date	Owner	Description
1.00	07-Jul-2010	JLU	Document created
1.01	22-Jul-2010	JLU	Mouse Emulator in GUI
1.02	05-Oct-2010	JLU	Minor esthetical changes

Copyrights

Copyright © 1997-2010, austriamicrosystems AG, Schloss Premstaetten, 8141 Unterpremstaetten, Austria-Europe. Trademarks Registered ®. All rights reserved. The material herein may not be reproduced, adapted, merged, translated, stored, or used without the prior written consent of the copyright owner.

All products and companies mentioned are trademarks or registered trademarks of their respective companies.

Disclaimer

Devices sold by austriamicrosystems AG are covered by the warranty and patent indemnification provisions appearing in its Term of Sale. austriamicrosystems AG makes no warranty, express, statutory, implied, or by description regarding the information set forth herein or regarding the freedom of the described devices from patent infringement. austriamicrosystems AG reserves the right to change specifications and prices at any time and without notice. Therefore, prior to designing this product into a system, it is necessary to check with austriamicrosystems AG for current information. This product is intended for use in normal commercial applications. Applications requiring extended temperature range, unusual environmental requirements, or high reliability applications, such as military, medical life-support or lifesustaining equipment are specifically not recommended without additional processing by austriamicrosystems AG for each application.

The information furnished here by austriamicrosystems AG is believed to be correct and accurate. However, austriamicrosystems AG shall not be liable to recipient or any third party for any damages, including but not limited to personal injury, property damage, loss of profits, loss of use, interruption of business or indirect, special, incidental or consequential damages, of any kind, in connection with or arising out of the furnishing, performance or use of the technical data herein. No obligation or liability to recipient or any third party shall arise or flow out of austriamicrosystems AG rendering of technical or other services.



Contact Information

Headquarters

austriamicrosystems AG
A-8141 Schloss Premstaetten, Austria
Tel: +43 (0) 3136 500 0
Fax: +43 (0) 3136 525 01

For Sales Offices, Distributors and Representatives, please visit:

<http://www.austriamicrosystems.com/contact>