

AS3635

Xenon Flash Driver with 5V IGBT Control

General Description

The AS3635 is a highly integrated photoflash charger with built-in IGBT driver.

A built-in 5V charge-pump guarantees constant IGBT drive at any battery voltage. The built-in timer turns OFF the charge-pump 20 seconds after charging.

In circuit fuse trimming allows to set the voltage on the photoflash capacitor to $\pm 3\%$ accuracy.

The AS3635 is available in a space-saving WL-CSP package measuring only $1.5\text{mm} \times 1.5\text{mm}$ and operates over the -30°C to 85°C temperature range.

Warning: Lethal voltages are present on applications using AS3635! Do not operate without training to handle high voltages.

Ordering Information and Content Guide appear at end of datasheet.

Key Benefits & Features

The benefits and features of AS3635, Xenon Flash Driver with 5V IGBT Control are listed below:

Figure 1:
Added Value Of Using AS3635

Benefits	Features
<ul style="list-style-type: none"> Very accurate flash capacitor charging voltage 	<ul style="list-style-type: none"> Photoflash voltage accuracy programmable to $\pm 3\%$ (in circuit One Time Programmable - OTP)
<ul style="list-style-type: none"> Simple PCB layout, easy integration 	<ul style="list-style-type: none"> No need for microvias in PCB
<ul style="list-style-type: none"> High integration reduces total BOM size 	<ul style="list-style-type: none"> Few external components <ul style="list-style-type: none"> Built-in 5V charge-pump for IGBT gate drive No Schottky diode needed No output voltage divider needed
<ul style="list-style-type: none"> Fast re-charge time 	<ul style="list-style-type: none"> Charge time $< 4\text{sec}$ @ $V_{\text{bat}} > 2.7\text{V}$, $C_{\text{FLASH}} = 22\mu\text{F}$
<ul style="list-style-type: none"> On-chip safety features 	<ul style="list-style-type: none"> Undervoltage lockout
<ul style="list-style-type: none"> Small PCB footprint and overall system size 	<ul style="list-style-type: none"> Available in a tiny WL-CSP Package 3×3 balls 0.5mm pitch, $1.5 \times 1.5\text{mm}$ package size

Applications

The AS3635 is ideal for Xenon Flash driver for mobile phones, PDA and DSC.

Figure 2:
Typical Operating Circuit

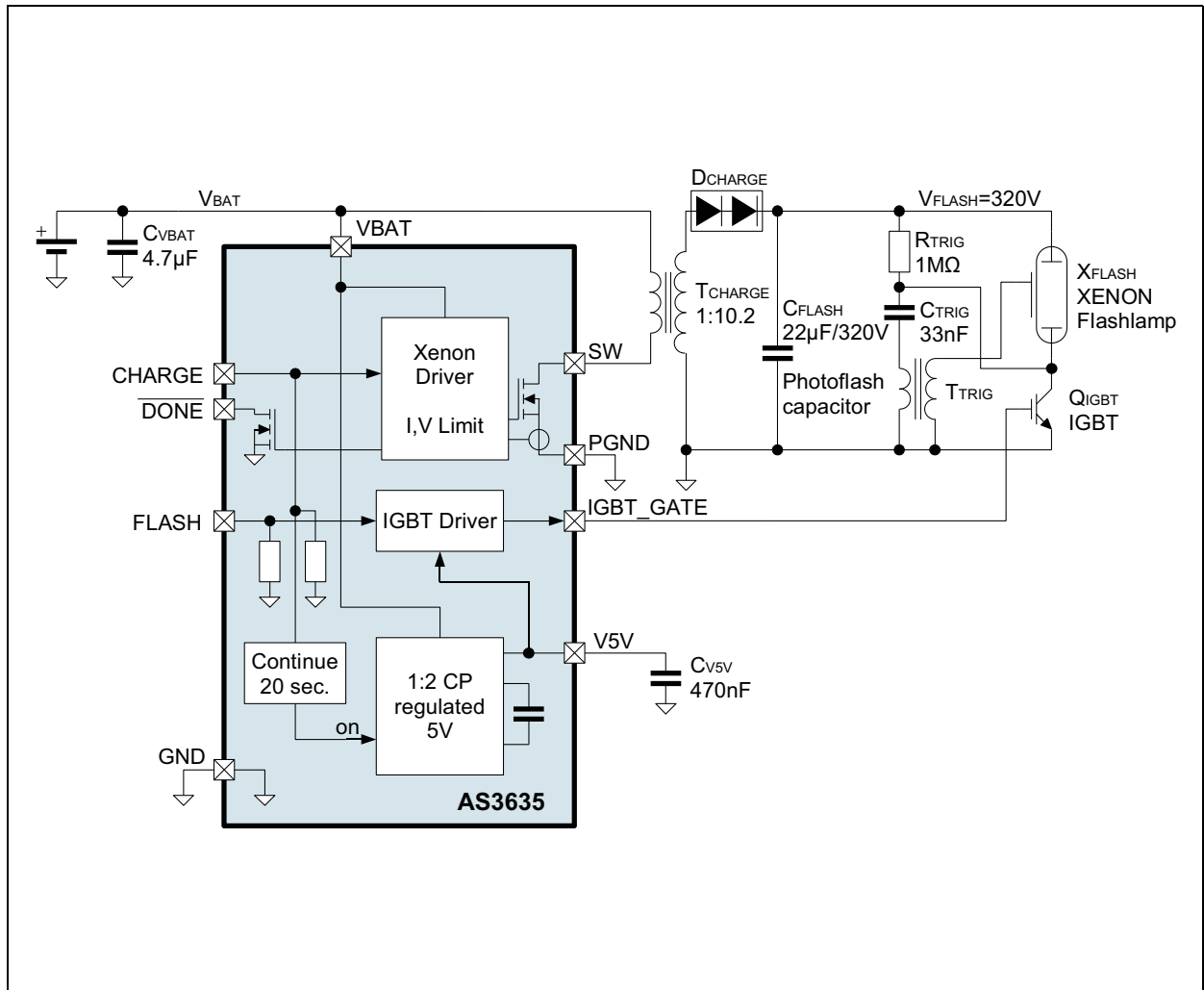

Pinout

Figure 3:
Pin Assignments (Top Through View)

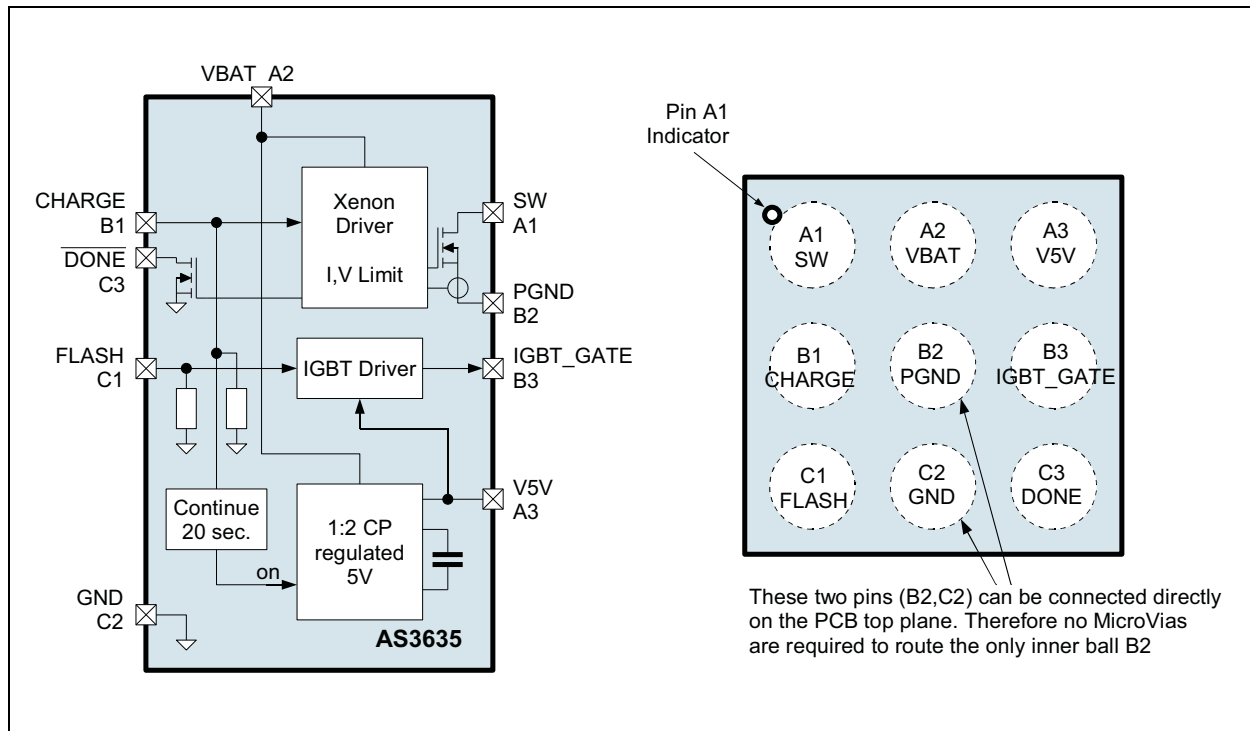

Figure 4:
Pin Description for AS3635

Pin Number	Pin Name	Description
A1	SW	Xenon DCDC converter switching node
A2	VBAT	Positive supply voltage input
A3	V5V	5V charge pump output
B1	CHARGE	Digital input pin, active high - enables charging of photoflash capacitor
B2	PGND	Power ground - connect to ground (GND)
B3	IGBT_GATE	IGBT gate control - internally level shifted to 5V (from pin V5V)
C1	FLASH	Digital input pin, active high - Enables flash (level shifted to IGBT_GATE)
C2	GND	Signal ground - connect to ground (GND)
C3	$\overline{\text{DONE}}$	Digital open drain output, active low - indicates end of charging

Absolute Maximum Ratings

Stresses beyond those listed in [Absolute Maximum Ratings](#) may cause permanent damage to the device. These are stress ratings only, and functional operation of the device at these or any other conditions beyond those indicated in [Electrical Characteristics](#), is not implied. Exposure to absolute maximum rating conditions for extended periods may affect device reliability.

Figure 5:
Absolute Maximum Ratings

Parameter	Min	Max	Units	Comments
V _{BAT} , V _{5V} to GND	-0.3	+7.0	V	
CHARGE, \overline{DONE} , FLASH to GND	-0.3	V _{BAT} + 0.3	V	Maximum 7.0V
IGBT_GATE to GND	-0.3	V _{5V} + 0.3	V	
SW to PGND	-0.3	+55.0	V	
PGND to GND	0.0	0.0	V	Connect PGND to GND directly below the pad (short connection recommended)
Input Pin Current without causing latchup	-100	+100 +I _{IN}	mA	Norm: EIA/JESD78
Continuous Power Dissipation (T_{AMB} = 70°C)				
Continuous power dissipation		0.76	W	P _T ⁽¹⁾
Electrostatic Discharge				
ESD (pins V _{BAT} , CHARGE, \overline{DONE} , FLASH ⁽²⁾)	±15000		V	Air Discharge to module; IEC 61000 -4 -2 test bench
	±8000		V	Contact Test to module; IEC 61000 -4 -2 test bench
ESD (HBM pins SW, IGBT_GATE, PGND, V _{5V})	±2000		V	Norm: MIL 883 E Method 3015
ESD CDM	±500		V	Norm: JEDEC JESD 22-C101C
ESD MM	±100		V	Norm: JEDEC JESD 22-A115-A level A

Parameter	Min	Max	Units	Comments
Temperature Ranges and Storage Conditions				
Storage Temperature Range	-55	125	°C	
Relative Humidity (non-condensing)	5	85	%	Non condensing
Body Temperature during Soldering		260	°C	According to IPC/JEDEC J-STD-020
Moisture Sensitivity Level (MSL)	MSL 1			Represents a max. floor life time of unlimited

Note(s):

1. Depending on actual PCB layout and PCB used
2. Assembled on PCB board (requires capacitor C_{VBAT}); special PCB layout (spark gaps) and external resistors required; system test for completed module (fully capsuled), no permanent interruption of operation

Electrical Characteristics

$V_{VBAT} = +2.51V$ to $+5.5V$, $T_{AMB} = -30^{\circ}C$ to $85^{\circ}C$, unless otherwise specified. Typical values are at $V_{VBAT} = +3.6V$, $T_{AMB} = 25^{\circ}C$, unless otherwise specified.

Figure 6:
Electrical Characteristics

Symbol	Parameter	Condition	Min	Typ	Max	Unit
General Operating Conditions						
V_{VBAT}	Supply Voltage		2.51 ⁽¹⁾	3.6	5.5	V
T_{AMB}	Operating Temperature		-30	25	85	$^{\circ}C$
$I_{SHUTDOWN}$	Shutdown Current	CHARGE = 0, charge pump OFF, FLASH = 0 $T_{AMB} < 50^{\circ}C$; $V_{VBAT} < 3.7V$		0.5	1.0	μA
V_{UVLO}	Undervoltage Lockout	Measured on pin VBAT	2.3		2.5	V
VFLASH Capacitor Charger						
V_{TRIP}	Comparator trip voltage	$V(SW) - V(VBAT)$ in circuit adjustable with OTP. $T_{AMB} = 0^{\circ}C$ to $50^{\circ}C$; only if V_{TRIP} is trimmed by ams	31.9	32.4	32.9	V
$V_{TRIPRANGE}$	Programming range of V_{TRIP}	5 bit programming 32.4V -11.2%/+10.5%; measured on pin SW allows in-circuit trimming of the final charged voltage V_{FLASH} on capacitor C_{FLASH}	29.6		35.8	V
V_{SW}	Maximum voltage on pin SW				50	V
I_{SW}	Switching current limit		0.75	0.9	1.05	A
R_{SW}	Switch ON resistance	Internal transistor between SW and PGND		0.4		Ω
t_{EOC_DET}		End of charge comparator trigger time - see Internal Circuit	128	138	148	ns
Charge Pump Parameters						
V_{V5V}	5V Charge pump output voltage	$5.25 > V_{VBAT} > 2.7V$	4.75	5.0	5.25	V
		$2.7V > V_{VBAT} > 2.51V$	4.3		5.25	
I_{CHRG_PUMP}	Charge Pump Operating Current	CHARGE= 0->1->0 (20 seconds timer running ⁽²⁾), charge pump ON includes $48\mu A$ for internal biasing and oscillator		163		μA

Symbol	Parameter	Condition	Min	Typ	Max	Unit	
f_{CLK}	Operating frequency			2.0		MHz	
IGBT Control - See IGBT Driver							
$IBGT_{RISE}$	IGBT control voltage rise time	Pin IGBT_GATE, rise/falltime 10% - 90%, $V_{5V}=5V$, $T_{AMB}=25^{\circ}C$, $V_{IN}=3.7V$, AS3635E, load: 6.5nF (capacitor)	0.171	0.214	0.256	μs	
$IBGT_{FALL}$	IGBT control voltage fall time		0.42	0.525	0.63	μs	
R_{IGBT_ON}	IGBT switching ON resistance	$T_{AMB}=-30^{\circ}C$ to $85^{\circ}C$	AS3635B	30	50	60	Ω
			AS3635E	5	15	20	Ω
I_{IGBT_SINK}	IGBT Sink Current	V_{IGBT_GATE} below 2.3V; $T_{AMB}=-30^{\circ}C$ to $85^{\circ}C$	AS3635B	10	15	20	mA
			AS3635E	52	60	70	mA
I_{IGBT_BOOST}	IGBT Boost Current	V_{IGBT_GATE} above 2.3V; $T_{AMB}=-30^{\circ}C$ to $85^{\circ}C$	40	46	53	mA	
Digital Interface							
V_{IH}	High Level Input Voltage	Pins CHARGE, FLASH; pin \overline{DONE} in trim mode	1.26			V	
V_{IL}	Low Level Input Voltage		0.0		0.54	V	
V_{OL}	Low Level Output Voltage	Pin \overline{DONE} , $I_{LOAD}=4mA$			0.2	V	
I_{LEAK}	Leakage current	Pin \overline{DONE}	-1		+1	μA	
R_{PD}	Pulldown resistance to GND ⁽³⁾	Pins CHARGE, FLASH		52		k Ω	
Recommended Transformer Parameters - see Recommended Transformers							
$L_{PRIMARY}$	Primary Inductance		6			μH	
L_{LEAK}	Primary Leakage Inductance				0.4	μH	
N	Turns Ratio	For $V_{FLASH}=320V$ (final charged voltage on C_{FLASH})	10.2				
$V_{ISOLATION}$	Isolation Voltage		500			V	
$I_{SATURATION}$	Primary Saturation Current		0.84			A	
$R_{PRIMARY}$	Primary Winding Resistance				0.4	Ω	

Symbol	Parameter	Condition	Min	Typ	Max	Unit
R _{SECONDARY}	Secondary Winding Resistance				60	Ω

Note(s):

1. Minimum V_{BAT} is set to 2.51V to allow a little margin to maximum V_{UVLO} undervoltage lockout of 2.5V.
2. Setting CHARGE=1 resets the timeout timer. Additionally the timeout timer is automatically stopped at power ON reset and once it has expired.
3. Measured with V_{BAT}=3.7V, CHARGE or FLASH = 1.26V

Typical Operating Characteristics

$V_{BAT} = 3.6V$, $T_{AMB} = 25^{\circ}C$ (unless otherwise specified).
 $C_{FLASH} = 22\mu F$, $T_{CHARGE Transformer} = TTRN-3822$,
 $Q_{IGBT} = RJP4002ANS$, $I_{SW} = 750mA$.

Figure 7:
Charging Waveform

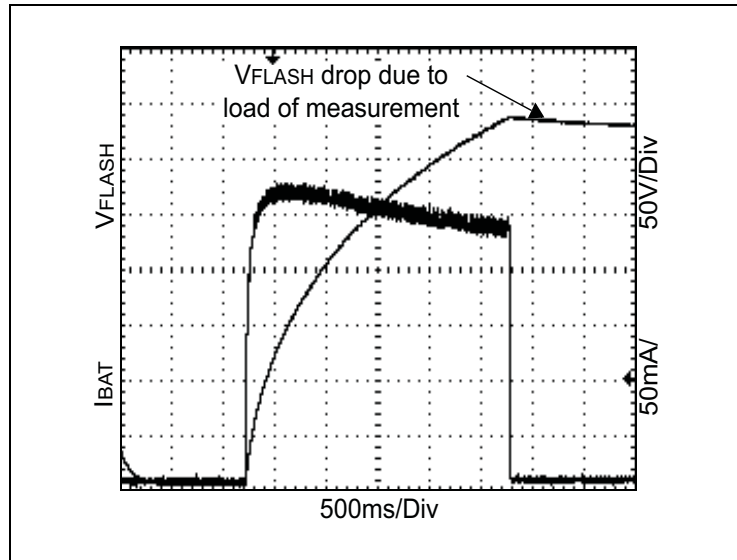

Figure 8:
Charging Time vs. VBAT

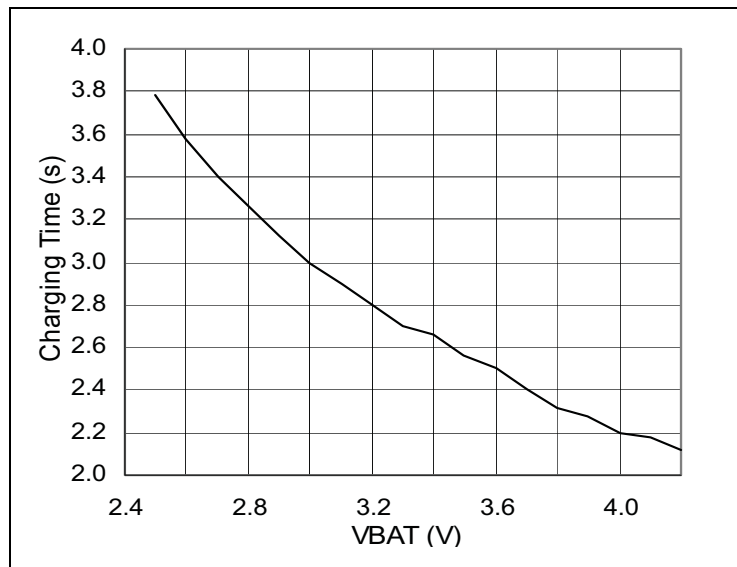

Figure 9:
Charging Waveform VBAT=2.51V

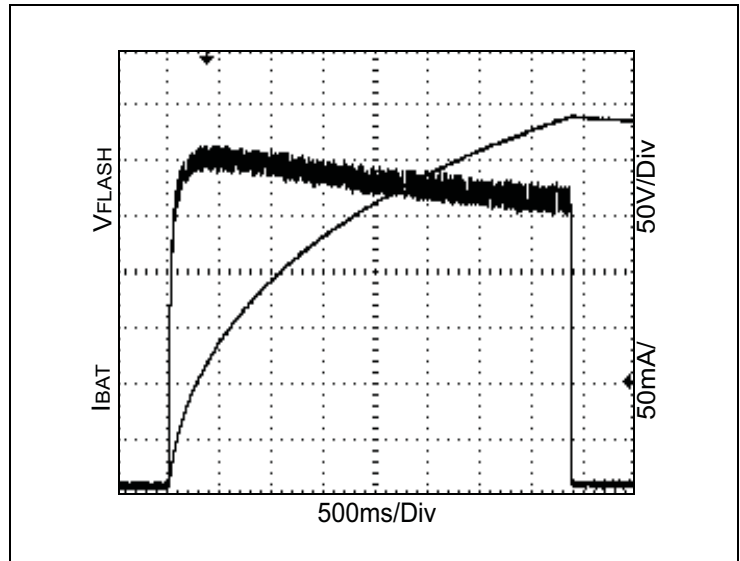

Figure 10:
Charging Waveform VBAT=4.2V

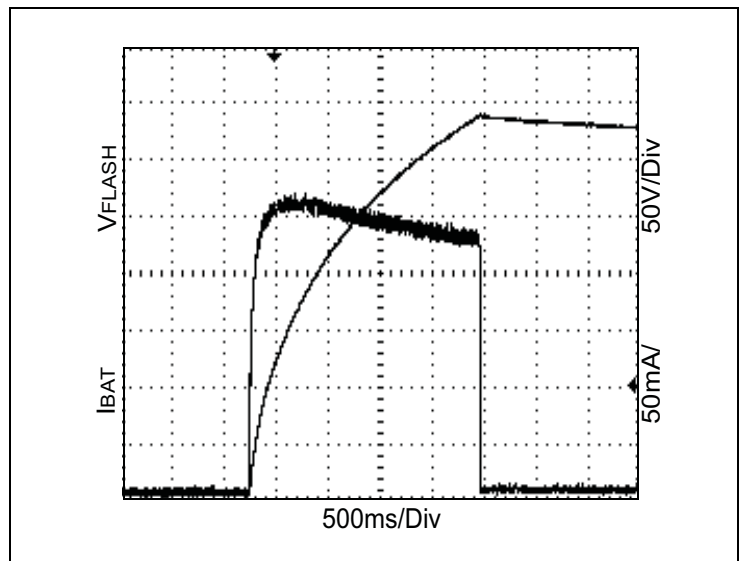

Figure 11:
Efficiency vs. V_{FLASH}

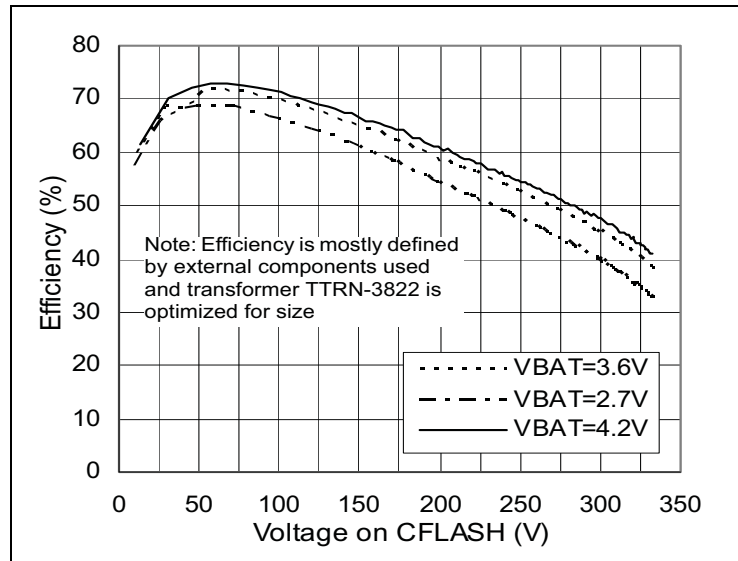

Figure 12:
Efficiency vs. Charging Time

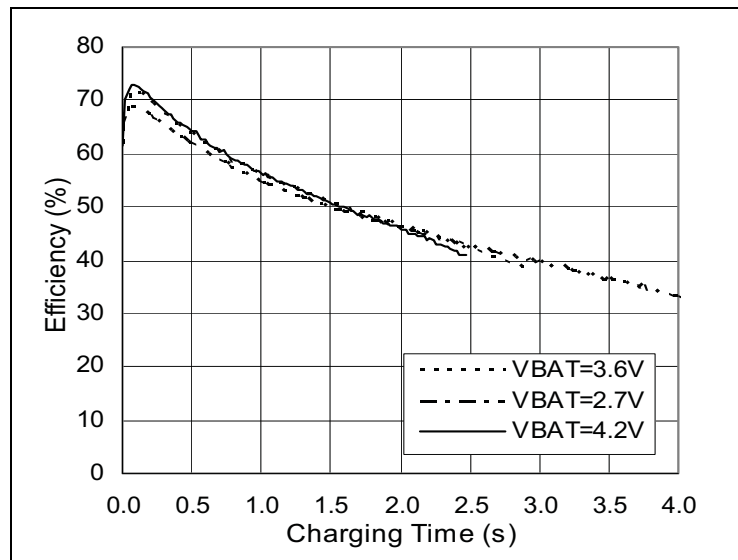

Figure 13:
End Of Charge Voltage vs. VBAT

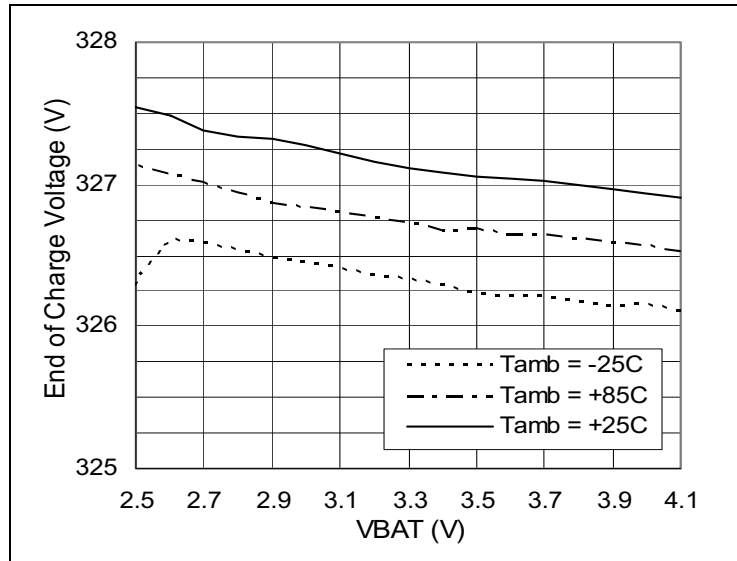

Figure 14:
IGBT_GATE Driving Waveform

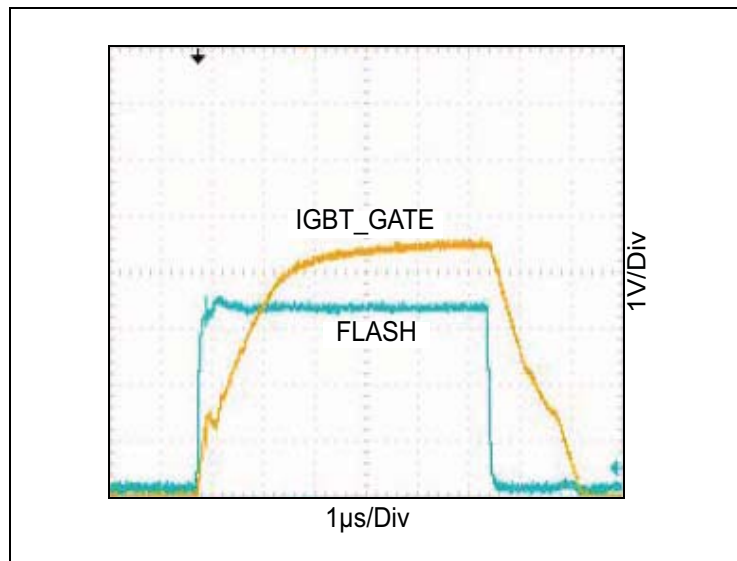

Figure 15:
SW Switching Waveform (Transformer: TTRN-3822)

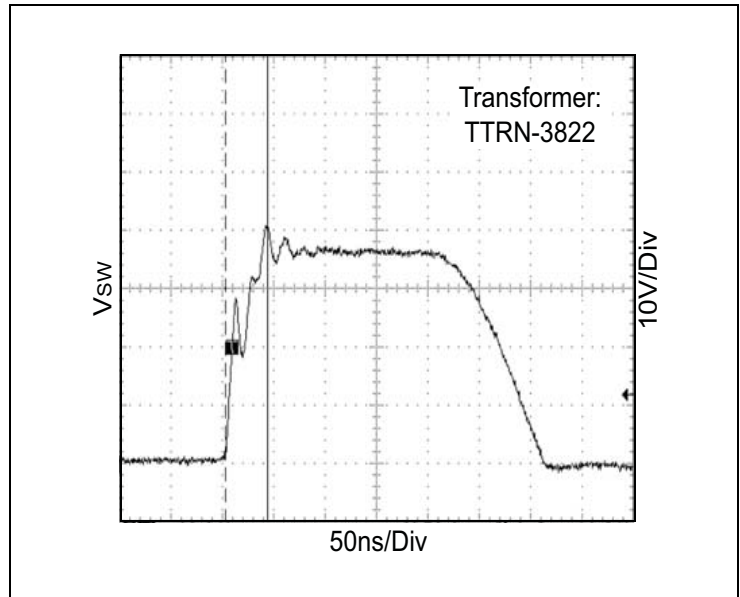

Figure 16:
SW Switching Waveform (Transformer: TTRN-3825)

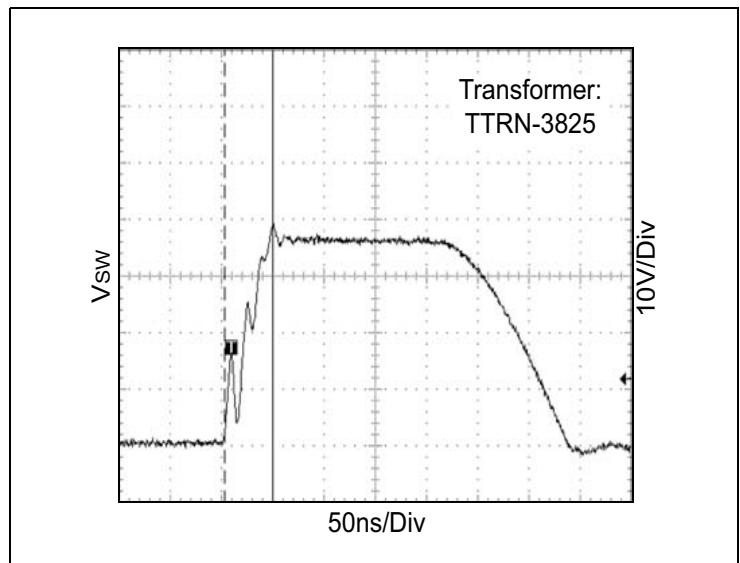

Figure 17:
V5V vs. VBAT (V5V CP ON)

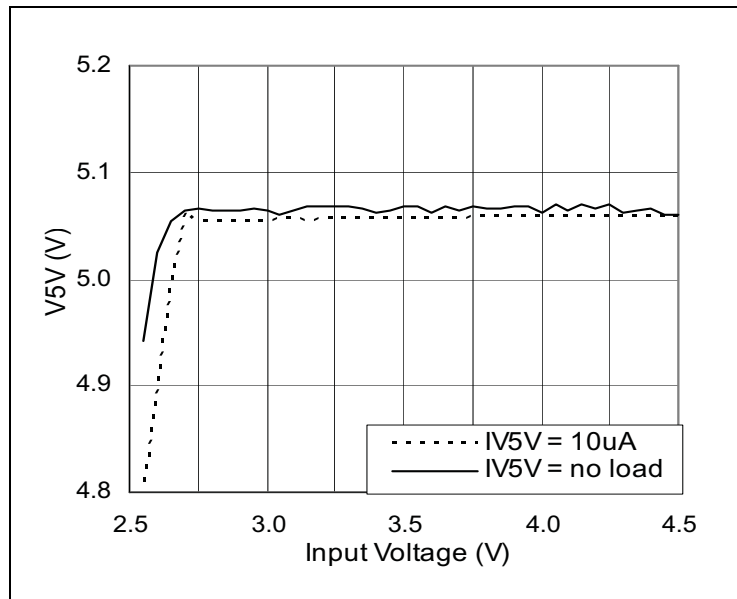
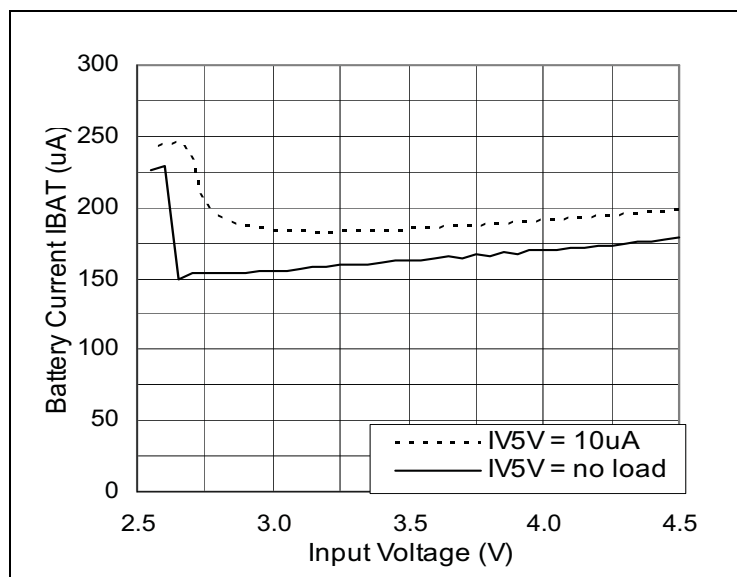

Figure 18:
Battery Current vs. VBAT (V5V CP ON)



Detailed Description

The AS3635 is a photoflash capacitor charger and an integrated IGBT driver for a Xenon flash. The capacitor charger charges V_{FLASH} to the final charging voltage (e.g. 320V) and the IGBT driver starts the actual Xenon flash.

Additionally a charge pump is included to generate a stable 5V supply for accurate control of the IGBT ON/OFF timings independent of the battery supply.

The final charged voltage (V_{FLASH}) can be in-field trimmed to e.g. 320V with the integrated OTP (one time programmable) memory (see section [Trimming Procedure](#)). V_{FLASH} can be exactly trimmed to the maximum allowed output voltage resulting in an improved use of the available energy in the photoflash capacitor.

Note(s): The AS3635 uses a WL-CSP (wafer level chip scale package) to optimize the PCB area required and minimize the module size. Therefore the actual DIE is visible (and it is not molded in plastic as for other packages like QFN or DFN) and the AS3635 is sensitive to external light. It has to be protected from direct light from the Xenon tube.

Internal Circuit

Figure 19:
Internal Circuit

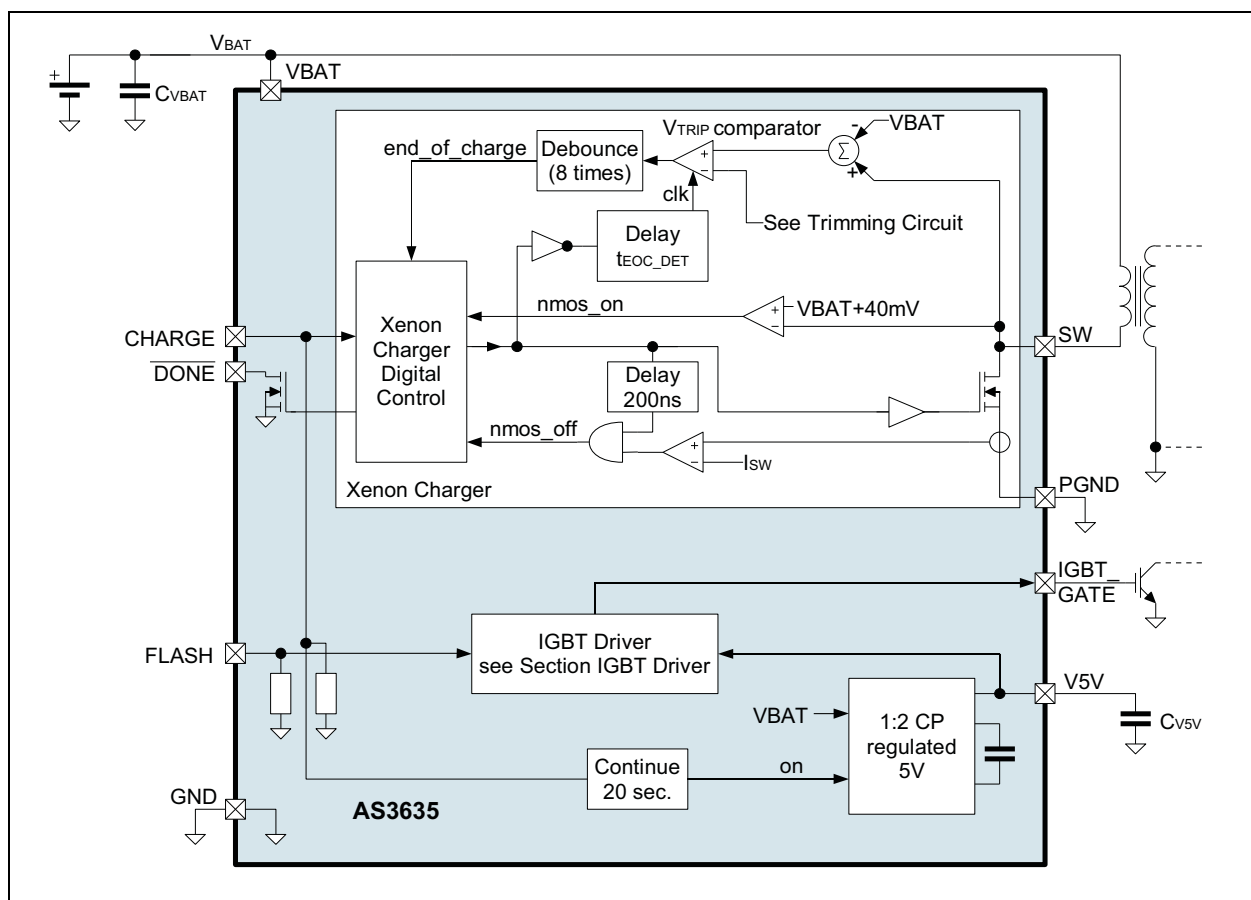

AS3635 Operation

The AS3635 allows charging and refresh cycles under complete software control. Two typical configurations are shown in [Figure 20](#) and [Figure 21](#):

[Figure 20](#) shows a configuration without any refresh between the pre-flash and the actual flash. Typically this is used for applications where no noise at all should be generated on the battery when the camera is performing e.g. white color balancing (between pre-flash and flash cycle).

Figure 20:
AS3635 Charging Cycle Without Recharging Between Pre-Flash and Flash

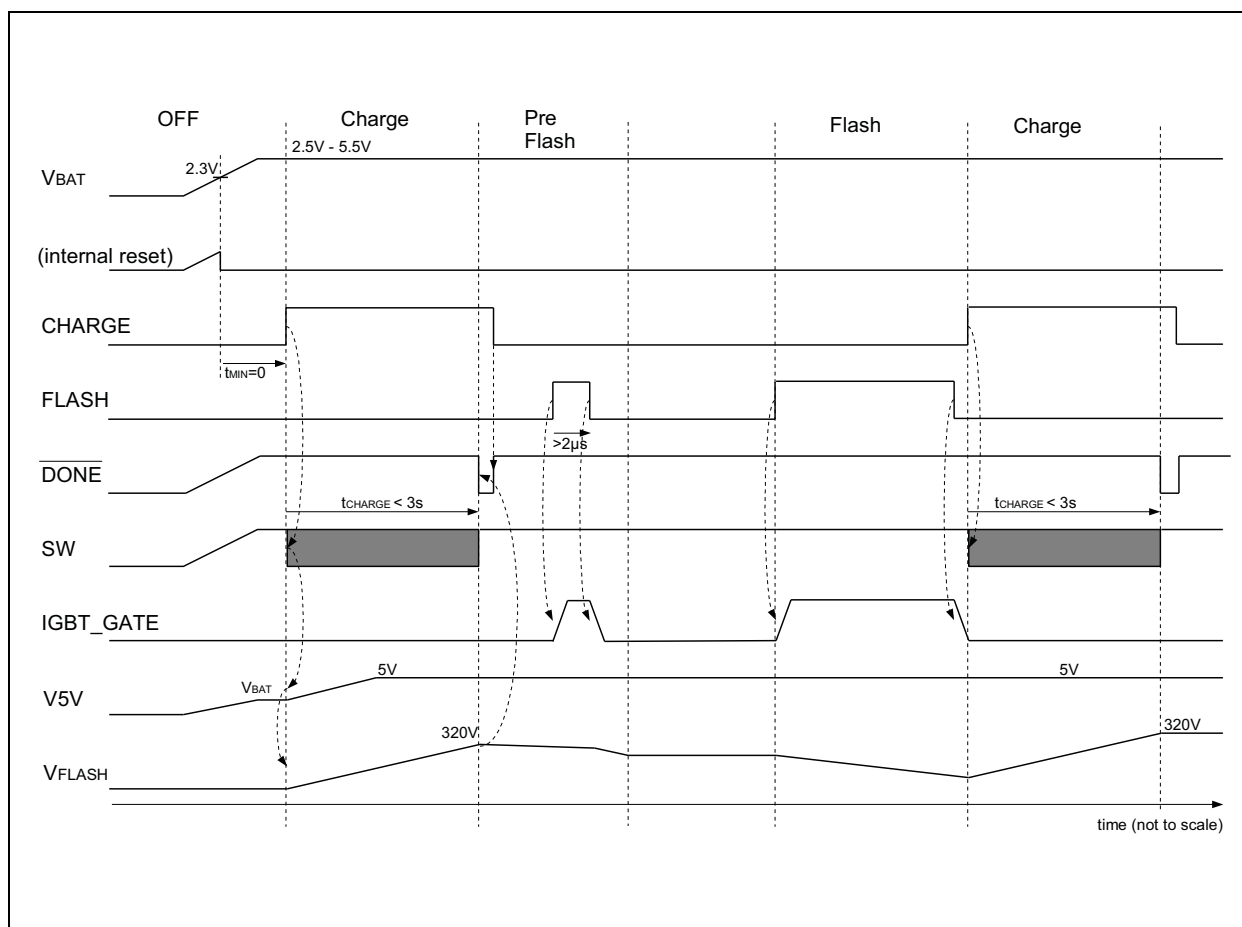
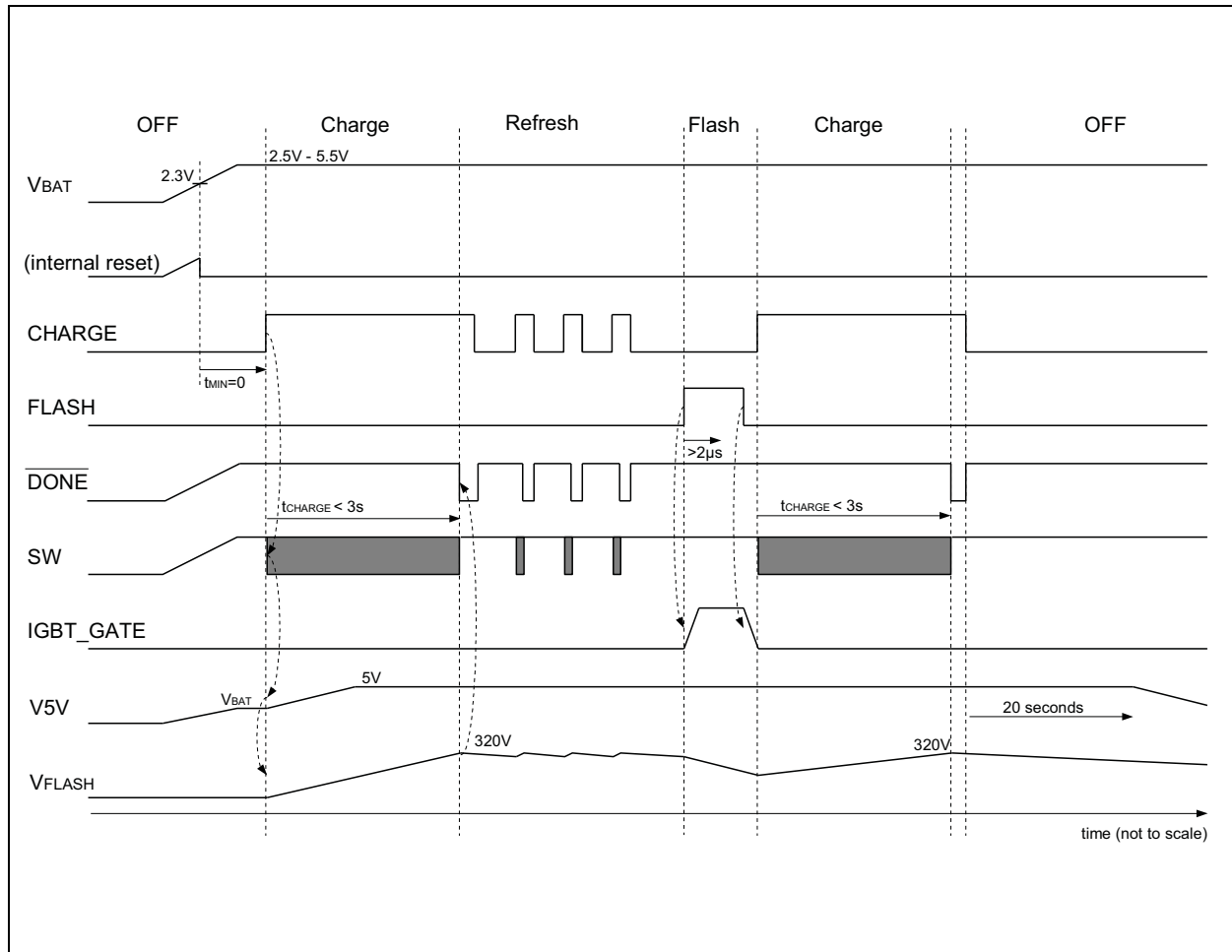

Figure 21 shows a configuration with continuous refresh of the voltage on the photoflash capacitor (V_{FLASH}). Typically this is used in application where the maximum flash energy should be used.

Figure 21:
AS3635 Charging Cycle With Continuous Recharging



A typical charging cycle and its voltages and current on the different pins and signals are shown in Figure 22:

Figure 22:
AS3635 Charging Cycle Details

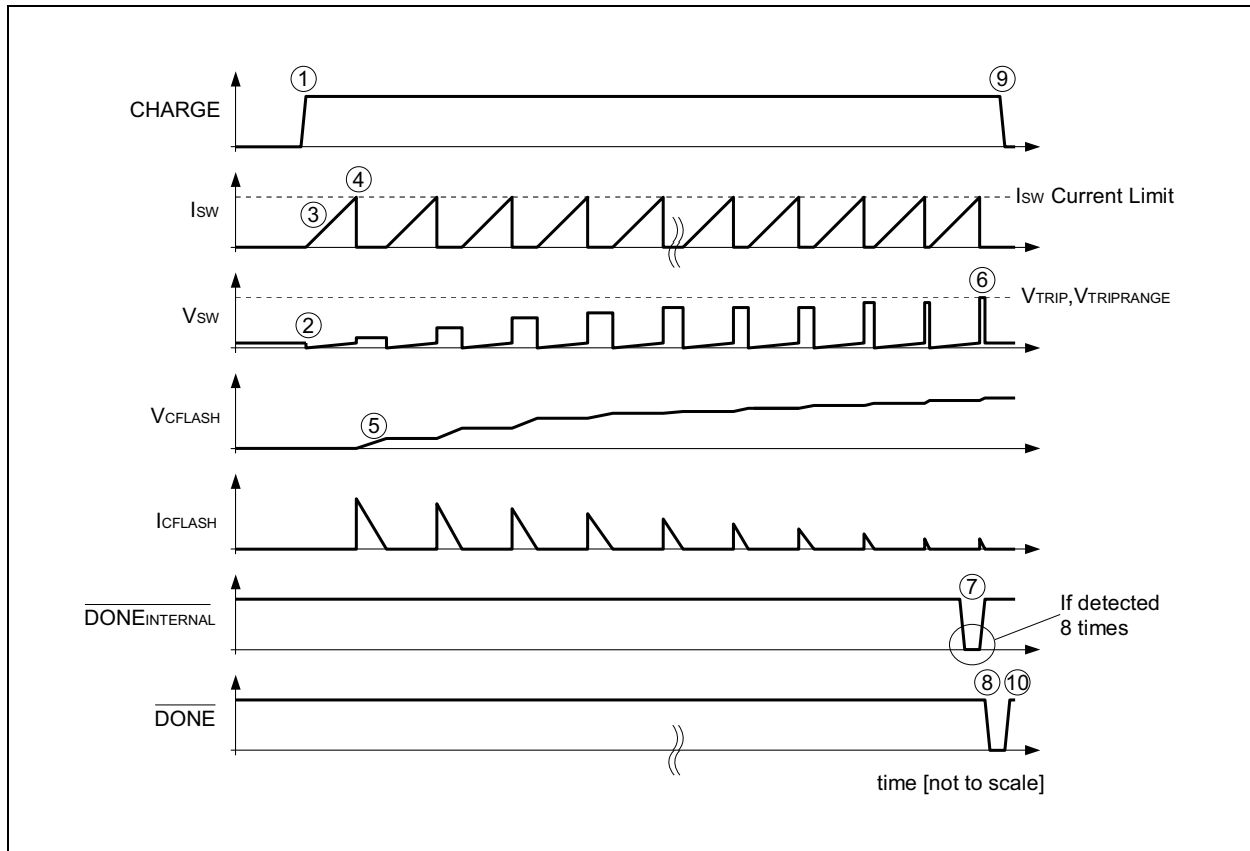

The input CHARGE is set to high and charging begins (1).

During a single cycle, the internal NMOS transistor connects the pin SW to PGND (2). Therefore the current I_{SW} rises (3) until it reaches I_{SW} current limit (4). Then the energy is transferred to the secondary side of the transformer and the voltage V_{CFLASH} on the flash capacitor C_{FLASH} rises (5).

The output voltage V_{CFLASH} gradually increases and once it hits the end of charge detection threshold (6) (detected on V_{SW} during the OFF time of the NMOS transistor between SW and PGND) 8 times (7)¹, \overline{DONE} is pulled low (8). When CHARGE is set to low afterwards (9), \overline{DONE} returns to high (10) finishing a full charging cycle.

Note(s): For simplicity the number of actual charging cycles (NMOS SW ON/OFF) are reduced in Figure 22.

1. The 8 cycles required for actual detection of the end of charge conditions are not shown in Figure 22.

Trimming Procedure

The final charging voltage on V_{FLASH} can be trimmed in-circuit to cancel inaccuracies of V_{FLASH} due to the transformer and diode. The trimming procedure is performed as follows:

Figure 23:
AS3635 Trimming Circuit⁽¹⁾

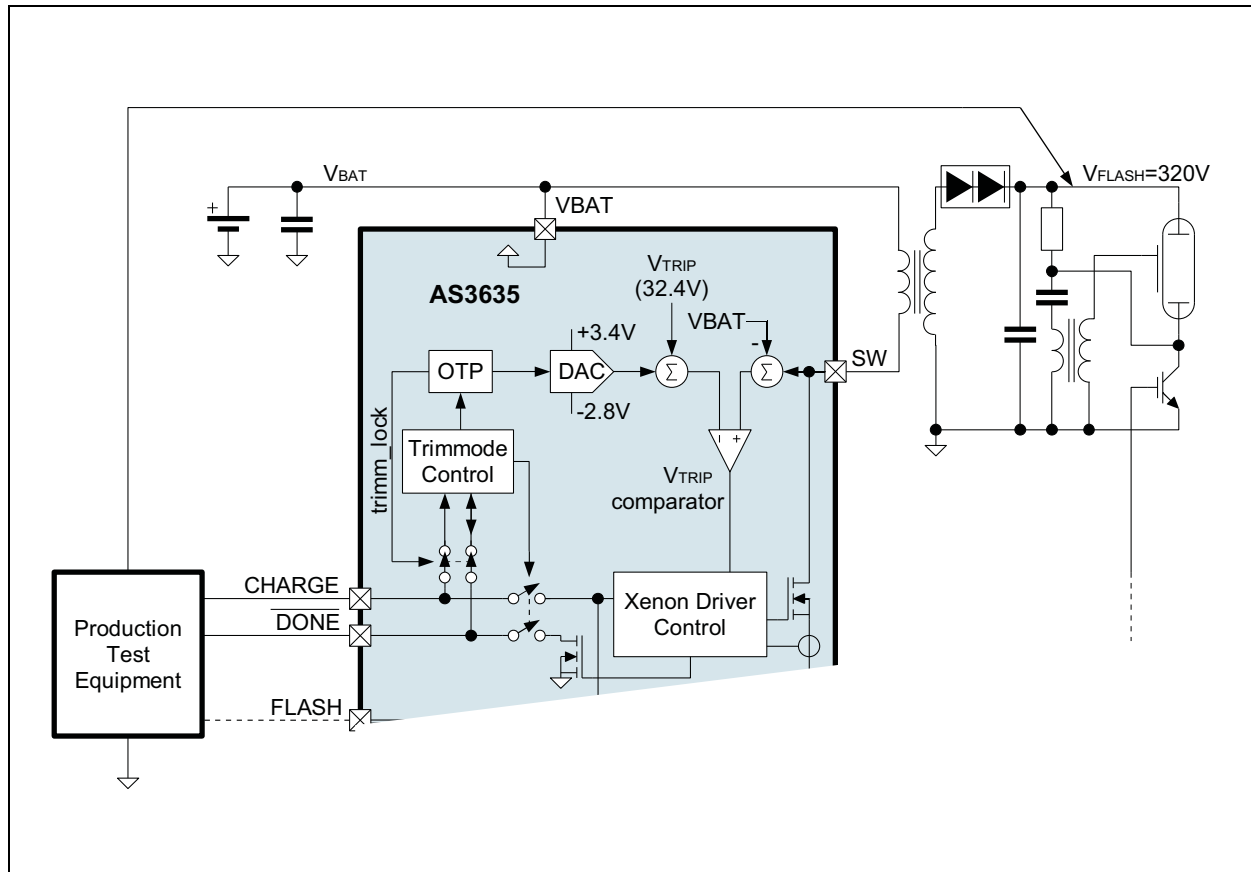

Note(s):

1. The internal voltages (e.g. +3.4V/-2.8V/32.4V) are internally scaled to fit in the supply voltage range

1. The production test equipment starts a charging cycle (CHARGE=1) and waits until DONE=0
2. The voltage on V_{FLASH} is measured and a correction code is calculated
3. The trimmode control is unlocked using a special sequence
4. The one time programmable memory (OTP) is programmed with the above calculated code
5. The trimmode control can be disabled by fusing the OTP bit trimm_lock

See **ams** application note 'AN3635_In-Production_Trimming'² for a detailed description of the trimming setup and the trimming procedure.

² Please contact **ams** for more information.

IGBT Driver

The internal circuit of the IGBT driver is shown in Figure 24:

Figure 24:
IGBT Driver Circuit

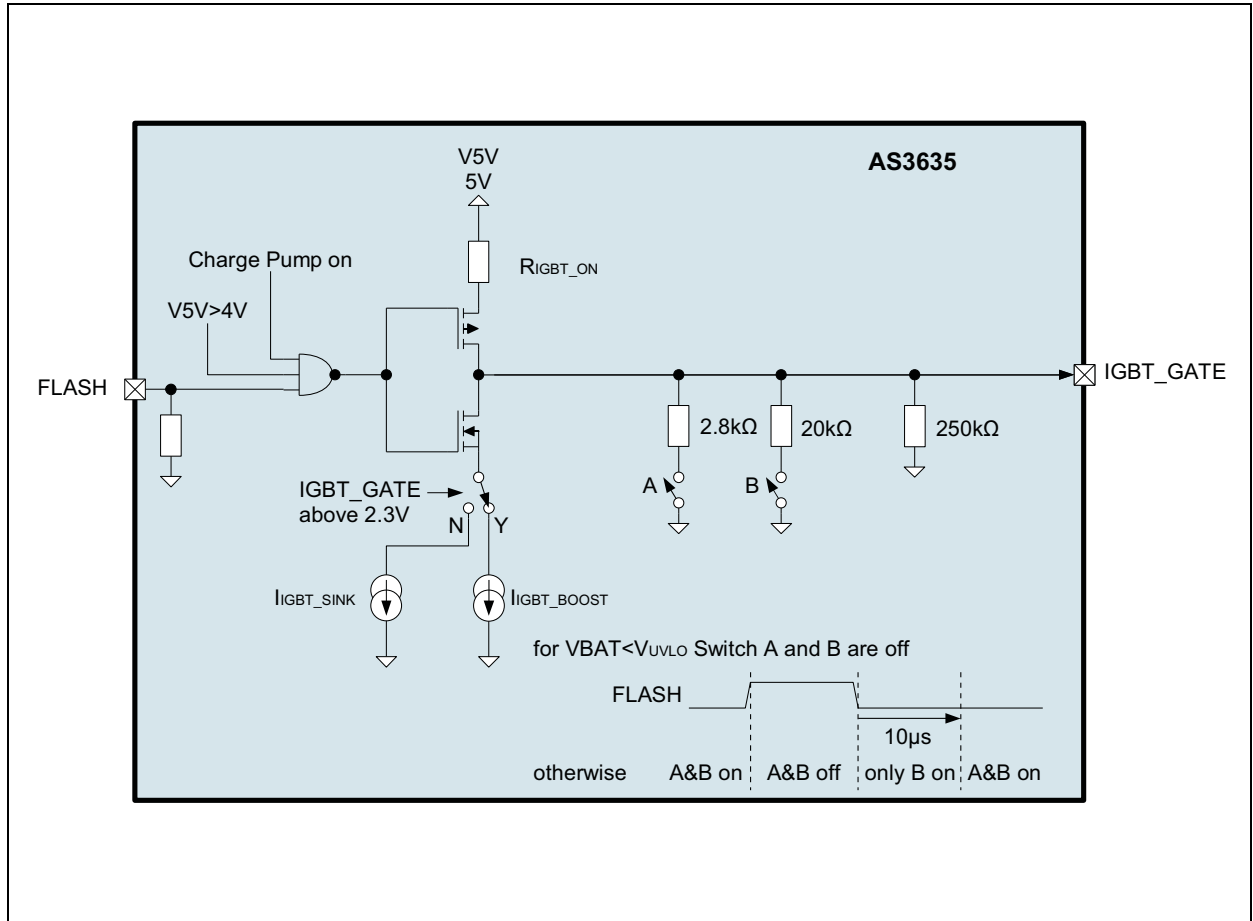

The IGBT driver is enable once the charge pump is switched ON and the voltage on pin V5V has reached 4V (to guarantee at least 4V driving signal for the IGBT).

The IGBT driver includes all required resistors and pulldowns to operate the IGBT without any external circuitry³. Do not add any external pulldown resistor on pin IGBT_GATE.

3. **Exception:** If the Sanyo IGBT TIG058E8 is used, add a series resistor of 50Ω for the gate drive. For Renesas RJP4006AGE add a series resistor of 68Ω.

ESD Protection Diodes

The internal ESD diodes are shown in [Figure 25](#) - do not operate ESD diodes in forward direction⁴:

Figure 25:
ESD Diodes

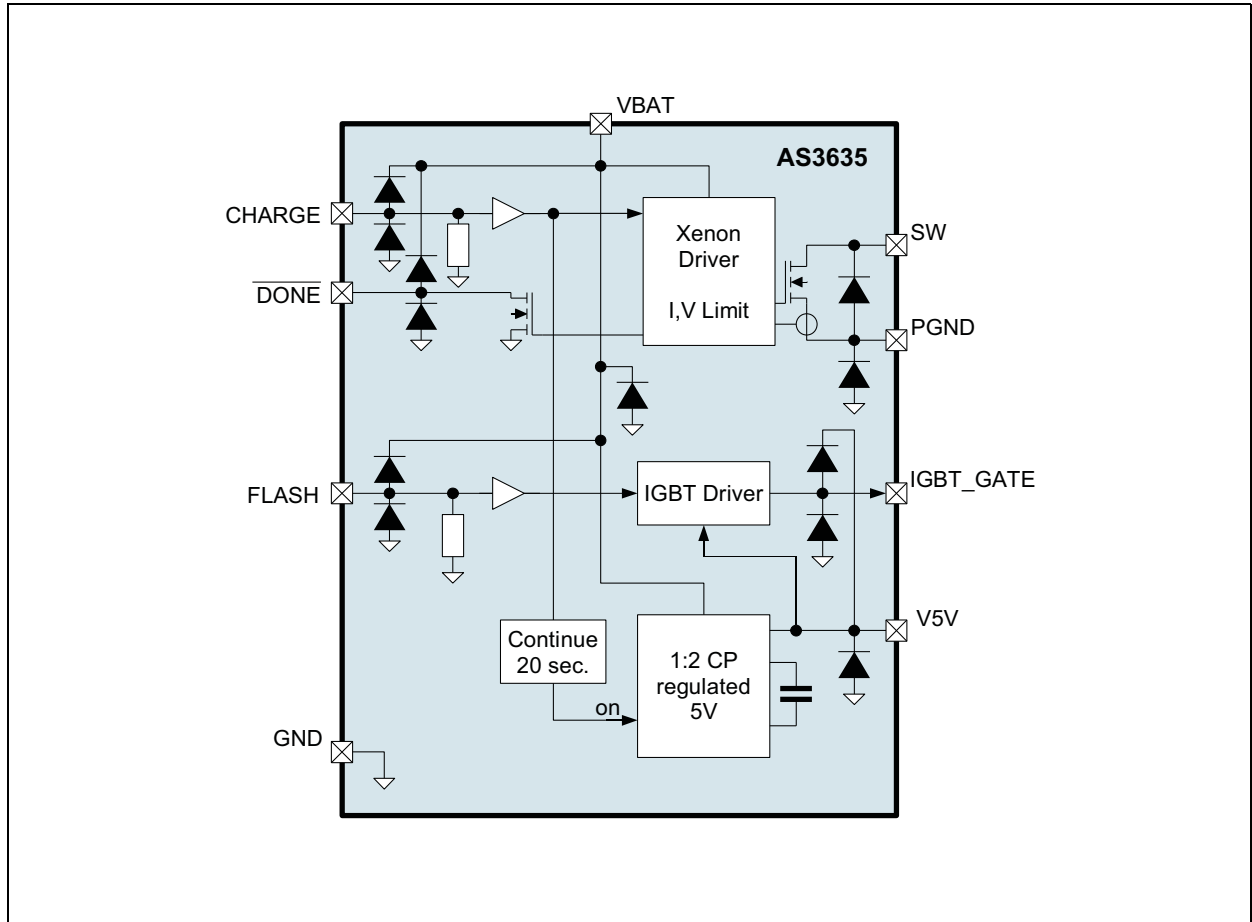

4. **Exception:** The diode between SW and PGND is designed to be operated in forward direction for very short pulses during charging.

Application Information

External Components

Transformers T_{CHARGE} and T_{TRIG}

Following transformers are recommend for the AS3635 (due to the OTP programming features see section [Trimming Procedure](#), the output voltage V_{FLASH} can be programmed):

Figure 26:
Recommended Transformers

Component	Part Number	N	L	Size (mm)	Manufacturer
T_{CHARGE}	C3-T2.5R	10.2	6.7 μ H	3.4x3.4x2.5	Mitsumi Electric www.mitsumi.co.jp
	TTRN-3825H	10.2	7 μ H	3.8x3.8x2.5	Tokyo Coil www.tokyocoil.com
	TTRN-3822H	10.2	7 μ H	3.8x3.8x2.2	
	TTRN-5820H	10.2	8.87 μ H	5.8x5.8x2.0	
	TTRN-0520H	10.41	8.35 μ H	5.0x5.0x2.0	
	LDT4520T-01	10.2	10 μ H	4.7x4.5x2.0	TDK www.tdk.com
ATB322515	10.2	7 μ H	3.2x2.5x1.55 (H is max)		
T_{TRIG}	BO-02			7.3x2.5(3.5)x2.2	Tokyo Coil www.tokyocoil.com

Always ensure that the voltage on pin SW does not exceed the AS3635 maximum V_{sw} specification during charging.
(see [Figure 6](#))

IGBT

As the AS3635 has an internal charge pump included, 2.5V, 2.7V and 4V IGBT can be used without limit on the supply V_{VBAT} . The IGBT is used for two purposes:

1. Powering of the Xenon tube and generating together with the oscillation circuit consisting of T_{TRIG} , C_{TRIG} , R_{TRIG} a sufficiently high trigger pulse to ignite the Xenon tube (about 3.5kV) - this is accomplished by a fast rising edge of the gate of the IGBT
2. Switching OFF the current through the Xenon tube at the end of the flash pulse to accurately control the light emitted by the flash. To protect the IGBT the switching OFF falling edge voltage should be less than 400V/ μ s (measured on the emitter of the IGBT)

Both requirements are achieved with the internal driving circuit of the AS3635. Internal OTP trimming allows to adopt to different trigger coils and IGBTs.

Figure 27:
Recommended IGBTs

Component	Part Number	Min. Drive Voltage	Size	Manufacturer
Q _{IGBT}	RJP4002ANS	2.5V	VSON-8 3 × 4.8mm	Renesas www.renesas.com
	RJP4003ANS	4.0V		
	RJP4006AGE ⁽¹⁾	2.7V	2.85×3.05×1.1 mm (H is max.)	
	GT8G133	4.0V	TSSOP-8 3.3 × 6.4mm	Toshiba www.semicon.toshiba.co.jp
	TIG058E8 ⁽²⁾	4.0V	ECH8 2.8 × 2.9mm	Sanyo www.sanyo.com

Note(s):

1. Add a series resistor of 68Ω in the gate drive.
2. Add a series resistor of 47Ω in the gate drive.

Photoflash Capacitor C_{FLASH}

The photoflash capacitor stores the energy for the flash. Its capacitance define the maximum available energy. Using higher value capacitors as shown in figure below is possible, but will increase the charging time.

It is recommended to use low ESR capacitors to avoid loosing power during flash (it is also possible to connect two capacitors in parallel to reduce ESR):

Figure 28:
Recommended Photoflash Capacitors

Component	Part Number	Capacitor	Voltage Rating	Size	Manufacturer
C _{FLASH}	330FW13A6.3X20	2×13.5μF ⁽¹⁾	330V	Cylinder 2 × l=24mm, d=7mm	Rubycon www.rubycon.co.jp

Note(s):

1. Different capacitor values are possible to be used together with the AS3635. Lower capacitor value will reduce charging time, lower ESR capacitor will improve light output energy and reduce losses in the capacitor during the flash pulse.

Photoflash Charger Rectification Diode D_{CHARGE}

The rectification diode should have very low parasitic capacitance⁵ and has to withstand the operating current and reverse voltages.

Figure 29:
Recommended Rectification Diodes

Component	Part Number	Parasitic Capacitor	Voltage Rating	Size	Manufacturer
D_{CHARGE}	FVO2R80	5pF	800V	1.25×2.5mm	Origin www.origin.co.jp
	GSD2004S	5pF / 2	2× 240V	SOT-23 2.4×3.0mm	Vishay www.vishay.com
	BAS21	5pF / 2	2× 250V	SC-70 2.0×2.1mm	OnSemi www.onsemi.com

Supply Capacitor C_{VBAT} and Charge Pump Capacitor C_{V5V}

Low ESR capacitors should be used to minimize VBAT ripple. Multi-layer ceramic capacitors are recommended since they have extremely low ESR and are available in small footprints. The capacitor should be located as close to the device as possible.

X5R dielectric material is recommended due to their ability to maintain capacitance over wide voltage and temperature range.

Figure 30:
Recommended C_{VBAT} and C_{V5V} Capacitor

Component	Part Number	C	TC Code	Rated Voltage	Size	Manufacturer
C_{V5V}	GRM155R60J474	470nF	X5R	6.3V	0402	Murata www.murata.com
	GRM155R60J105 GRM155R61A105	1μF	X5R	6.3V 10V	0402	
C_{VBAT}	GRM188R60J475	4.7μF	X5R	6.3V	0603	

If a different output capacitor is chosen, ensure low ESR values and voltage ratings.

5. A low parasitic capacitance improves charging efficiency.

PCB Layout Guideline

Following layout recommendations apply:

1. Keep the path (and area) of GND - C_{VBAT} - VBAT - T_{CHARGE} (primary) - SW - GND as short as possible to minimize the leakage inductance of T_{CHARGE} and ensure a proper supply connection for the AS3635
2. Place C_{VBAT} as close as possible to the AS3635.
3. Ensure wide and short PCB paths for the path GND - C_{FLASH} - X_{FLASH} - Q_{IGBT} - GND to allow 150A to flow during the flash pulse. Connect this GND only at a single place to the main GND plane.
4. The IGBT has two ground connections: One ground for the driving input and one ground for the power path.
5. Ensure larger spacings for all high voltage paths; check with the PCB manufacturer to ensure proper minimum spacing for 320V paths and 4kV (Xenon tube trigger pin) paths.
6. Minimize the parasitic capacitance of the PCB on the anode of D_{CHARGE} especially to GND and V_{FLASH}
7. See **ams** "WLP-CSP-Handling-Guidelines_1V0.pdf"⁶ for proper handling, PCB layout and soldering of the WL-CSP AS3635 device.

See **ams** demoboard layout (described in application note 'AN3635'⁶).

6. Please contact **ams** for more information.

Package Drawings & Markings

Figure 31:
9 Pin WL-CSP 1.5 × 1.5mm Marking

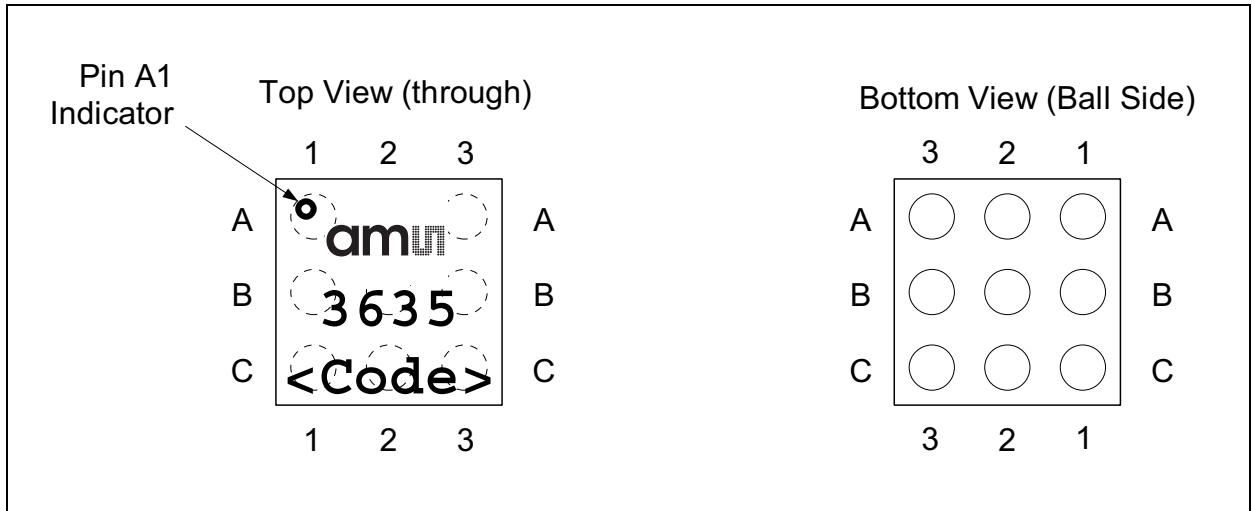

Line 1: **ams** logo
 Line 2: 3635 and version code (e.g. 'A' or 'B')
 Line 3: <Code>
 Tracecode (4 characters)

Figure 32:
9 Pin WL-CSP 1.5 × 1.5mm Package Dimensions

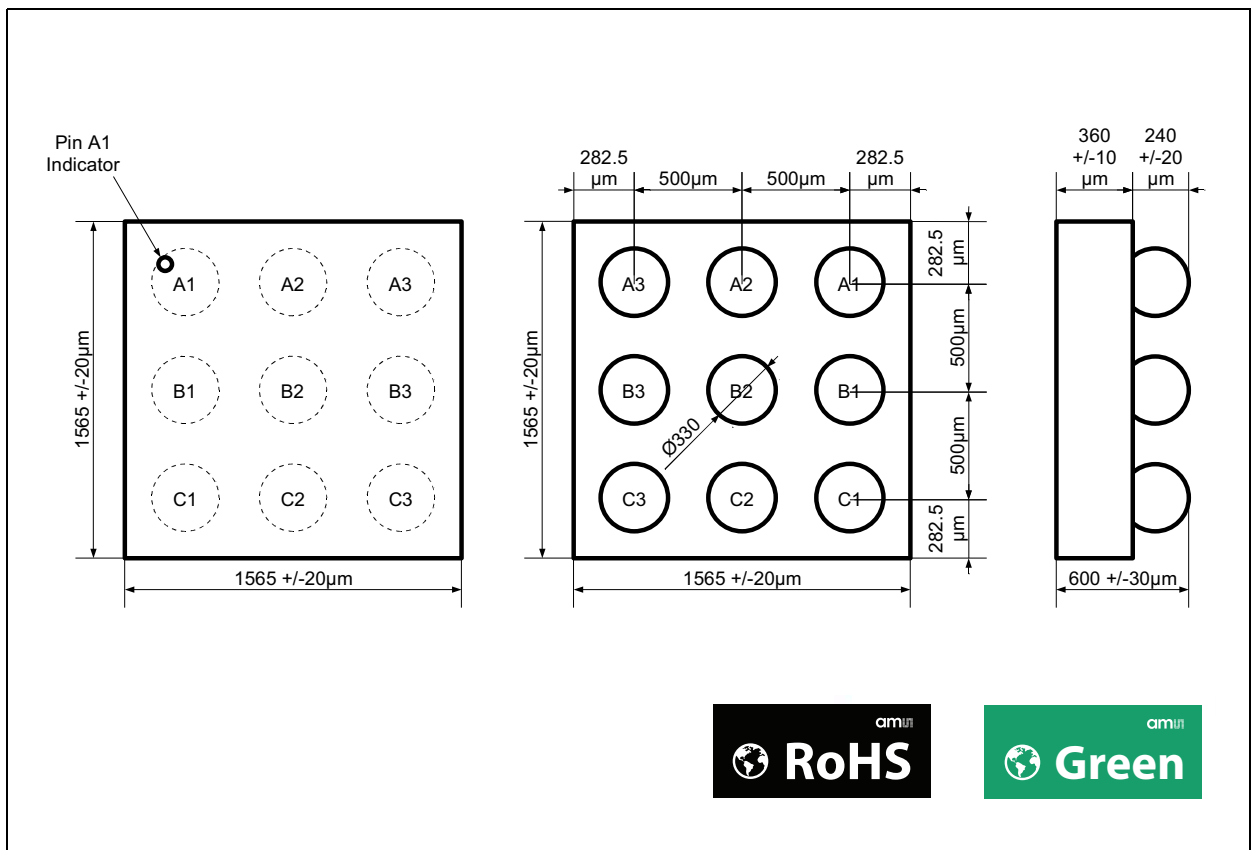

Ordering & Contact Information

The devices are available as the standard products shown in Figure 33.

Figure 33:
Ordering Information

Ordering Code	Marking	Description	Package	Delivery Form	Delivery Quantity
AS3635B-ZWLT	3635B	Xenon Flash Driver (5V IGBT Control) I_{SW} (charging current peak) = 900mA $R_{IGBT_ON} = 50\Omega$ $I_{IGBT_SINK} = 15mA$ $I_{IGBT_BOOST} = 46mA$ V_{TRIP} trimmed by customer	9-pin WL-CSP (1.5mm × 1.5mm)	Tape & Reel	6500
AS3635E-ZWLT	3635E	Xenon Flash Driver (5V IGBT Control) I_{SW} (charging current peak) = 900mA $R_{IGBT_ON} = 15\Omega$ $I_{IGBT_SINK} = 60mA$ $I_{IGBT_BOOST} = 46mA$ V_{TRIP} trimmed by customer	9-pin WL-CSP (1.5mm × 1.5mm)	Tape & Reel	6500

Description: AS3635V-ZWLT

V ... AS3635 version, either B or E

Z ... Temperature range -30°C to 85°C

WL ... Wafer Level Chip Scale Package (WL-CSP)

T ... Delivery form Tape & Reel

Buy our products or get free samples online at:

www.ams.com/ICdirect

Technical Support is available at:

www.ams.com/Technical-Support

Provide feedback about this document at:

www.ams.com/Document-Feedback

For further information and requests, e-mail us at:

ams_sales@ams.com

For sales offices, distributors and representatives, please visit:

www.ams.com/contact

Headquarters

ams AG
 Tobelbaderstrasse 30
 8141 Unterpremstaetten
 Austria, Europe

Tel: +43 (0) 3136 500 0

Website: www.ams.com

RoHS Compliant & ams Green Statement

RoHS: The term RoHS compliant means that ams AG products fully comply with current RoHS directives. Our semiconductor products do not contain any chemicals for all 6 substance categories, including the requirement that lead not exceed 0.1% by weight in homogeneous materials. Where designed to be soldered at high temperatures, RoHS compliant products are suitable for use in specified lead-free processes.

ams Green (RoHS compliant and no Sb/Br): ams Green defines that in addition to RoHS compliance, our products are free of Bromine (Br) and Antimony (Sb) based flame retardants (Br or Sb do not exceed 0.1% by weight in homogeneous material).

Important Information: The information provided in this statement represents ams AG knowledge and belief as of the date that it is provided. ams AG bases its knowledge and belief on information provided by third parties, and makes no representation or warranty as to the accuracy of such information. Efforts are underway to better integrate information from third parties. ams AG has taken and continues to take reasonable steps to provide representative and accurate information but may not have conducted destructive testing or chemical analysis on incoming materials and chemicals. ams AG and ams AG suppliers consider certain information to be proprietary, and thus CAS numbers and other limited information may not be available for release.

Copyrights & Disclaimer

Copyright ams AG, Tobelbader Strasse 30, 8141 Unterpremstaetten, Austria-Europe. Trademarks Registered. All rights reserved. The material herein may not be reproduced, adapted, merged, translated, stored, or used without the prior written consent of the copyright owner.

Devices sold by ams AG are covered by the warranty and patent indemnification provisions appearing in its General Terms of Trade. ams AG makes no warranty, express, statutory, implied, or by description regarding the information set forth herein. ams AG reserves the right to change specifications and prices at any time and without notice. Therefore, prior to designing this product into a system, it is necessary to check with ams AG for current information. This product is intended for use in commercial applications. Applications requiring extended temperature range, unusual environmental requirements, or high reliability applications, such as military, medical life-support or life-sustaining equipment are specifically not recommended without additional processing by ams AG for each application. This product is provided by ams AG "AS IS" and any express or implied warranties, including, but not limited to the implied warranties of merchantability and fitness for a particular purpose are disclaimed.

ams AG shall not be liable to recipient or any third party for any damages, including but not limited to personal injury, property damage, loss of profits, loss of use, interruption of business or indirect, special, incidental or consequential damages, of any kind, in connection with or arising out of the furnishing, performance or use of the technical data herein. No obligation or liability to recipient or any third party shall arise or flow out of ams AG rendering of technical or other services.

Document Status

Document Status	Product Status	Definition
Product Preview	Pre-Development	Information in this datasheet is based on product ideas in the planning phase of development. All specifications are design goals without any warranty and are subject to change without notice
Preliminary Datasheet	Pre-Production	Information in this datasheet is based on products in the design, validation or qualification phase of development. The performance and parameters shown in this document are preliminary without any warranty and are subject to change without notice
Datasheet	Production	Information in this datasheet is based on products in ramp-up to full production or full production which conform to specifications in accordance with the terms of ams AG standard warranty as given in the General Terms of Trade
Datasheet (discontinued)	Discontinued	Information in this datasheet is based on products which conform to specifications in accordance with the terms of ams AG standard warranty as given in the General Terms of Trade, but these products have been superseded and should not be used for new designs

Revision Information

Changes from 1.4-8 to current revision 1-49 (2015-Nov-23)	Page
Content of austriamicrosystems datasheet was converted to latest ams design	
Updated Figure 1	1
Updated Figure 33 and text below	27

Note(s):

1. Page and figure numbers for the previous version may differ from page and figure numbers in the current revision.
2. Correction of typographical errors is not explicitly mentioned.

Content Guide

1	General Description
2	Key Benefits & Features
3	Applications
4	Pinout
5	Absolute Maximum Ratings
7	Electrical Characteristics
10	Typical Operating Characteristics
16	Detailed Description
16	Internal Circuit
17	AS3635 Operation
20	Trimming Procedure
21	IGBT Driver
22	ESD Protection Diodes
23	Application Information
23	External Components
23	Transformers TCHARGE and TTRIG
23	IGBT
24	Photoflash Capacitor CFLASH
25	Photoflash Charger Rectification Diode DCHARGE
25	Supply Capacitor CVBAT and Charge Pump Capacitor CV5V
26	PCB Layout Guideline
27	Package Drawings & Markings
28	Ordering & Contact Information
30	RoHS Compliant & ams Green Statement
31	Copyrights & Disclaimer
32	Document Status
33	Revision Information